

# TMD Physics with a Solenoidal Large Intensity Device (SoLID) at 12-GeV Jefferson Lab

Solid Collaboration Meeting, Nov 7-8, 2014

*Haiyan Gao*

*Duke University*

*Durham, NC, U.S.A.*



# *QCD: still unsolved in non-perturbative*

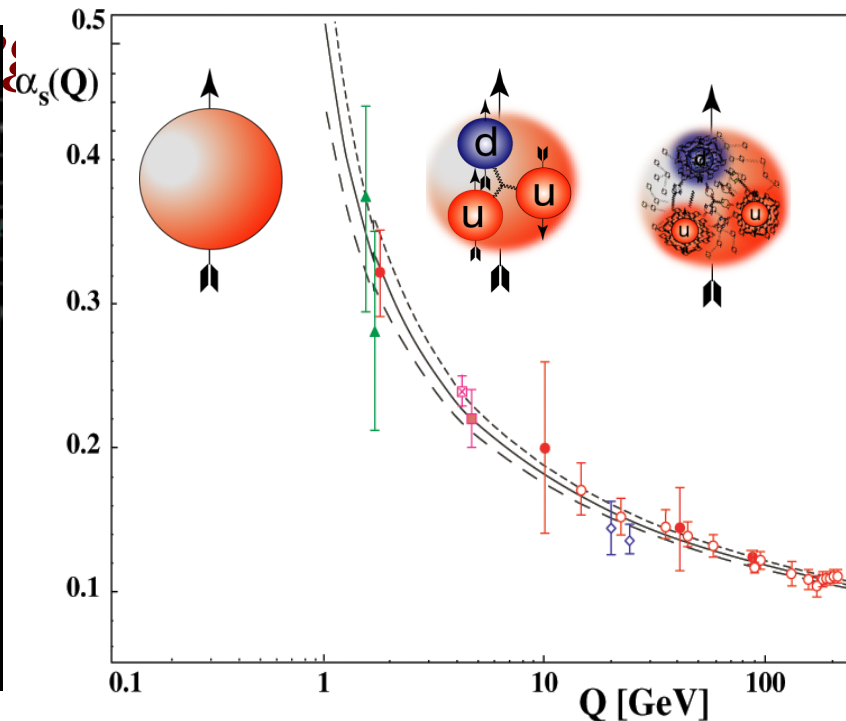
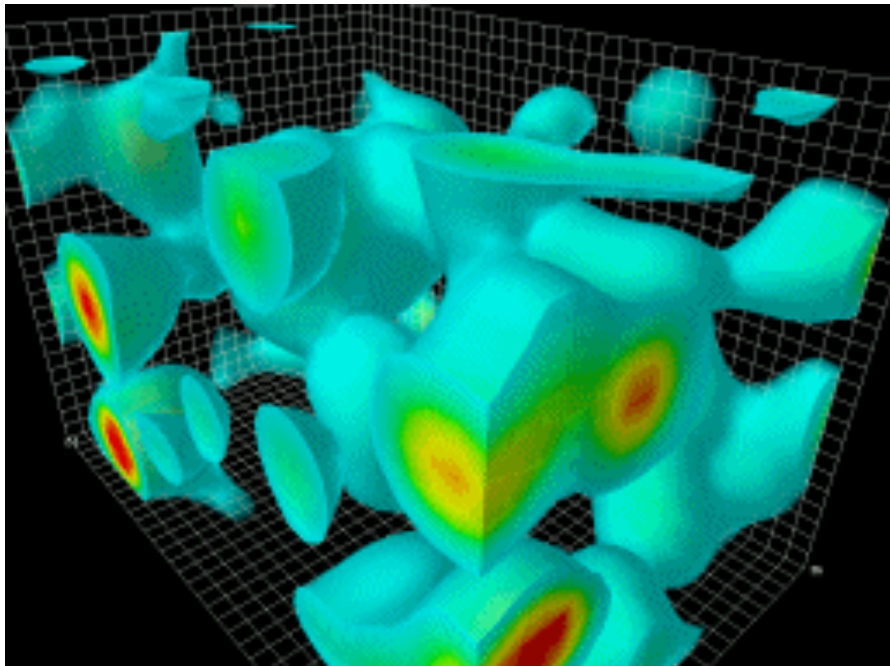

*Gauge bosons: gluons (8)*

- 2004 Nobel prize for “asymptotic freedom”
- **non-perturbative regime QCD ?????**
- One of the top 10 challenges for physics!
- QCD: Important for discovering new physics beyond SM
- **Nucleon structure is one of the most active areas**

# What is inside the proton/neutron?

1933: Proton's magnetic moment



Nobel Prize  
In Physics 1943

Otto Stern

1960: Elastic e-p scattering

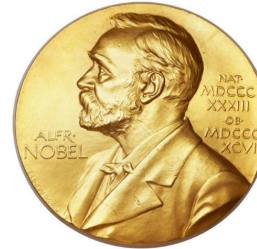

Nobel Prize  
In Physics 1961

Robert Hofstadter

$$g \neq 2$$

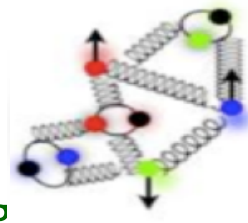

Form factors  $\rightarrow$  Charge distributions

1969: Deep inelastic e-p scattering

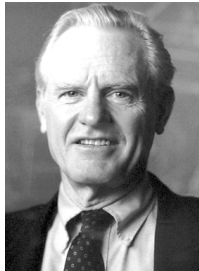
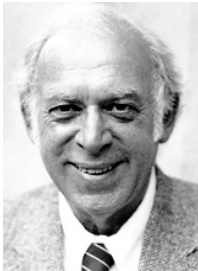

Nobel Prize in Physics 1990

Jerome I. Friedman,

Henry W. Kendall,

Richard E. Taylor

1974: QCD Asymptotic Freedom



Nobel Prize in Physics 2004

David J. Gross,

H. David Politzer,

Frank Wilczek

# The Incomplete Nucleon: Spin Puzzle

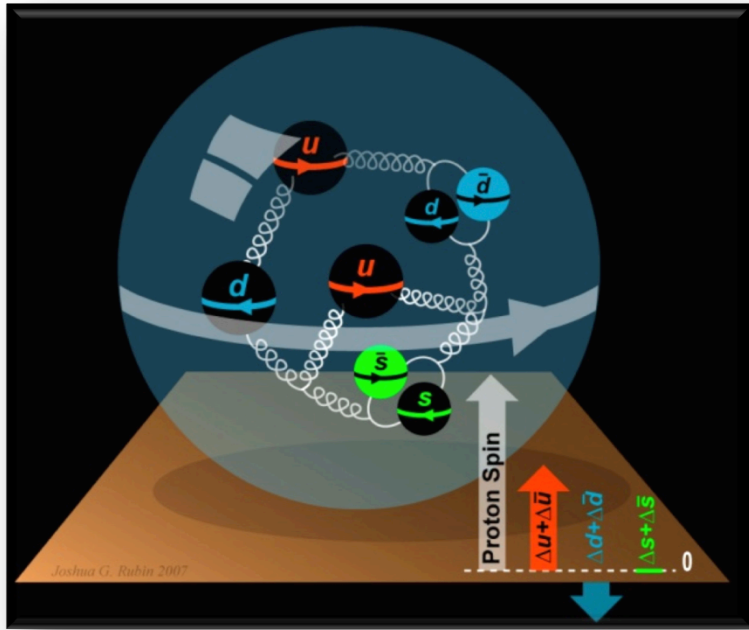

$$\frac{1}{2} = \frac{1}{2} \Delta\Sigma(\mu) + L_q(\mu) + J_g(\mu)$$

[X. Ji, 1997]

Jaffe-Manohar 1990

Chen *et al.* 2008

Wakamatsu 2009,2010

- DIS  $\rightarrow \Delta\Sigma \cong 0.30$
- RHIC + DIS  $\rightarrow \Delta g$  not small
- $\rightarrow L_q$

**Orbital angular momentum of quarks  
gluons is important**  
*Understanding of spin-orbit correlation  
(atomic hydrogen, topological insulator*

**How to access OAM?**

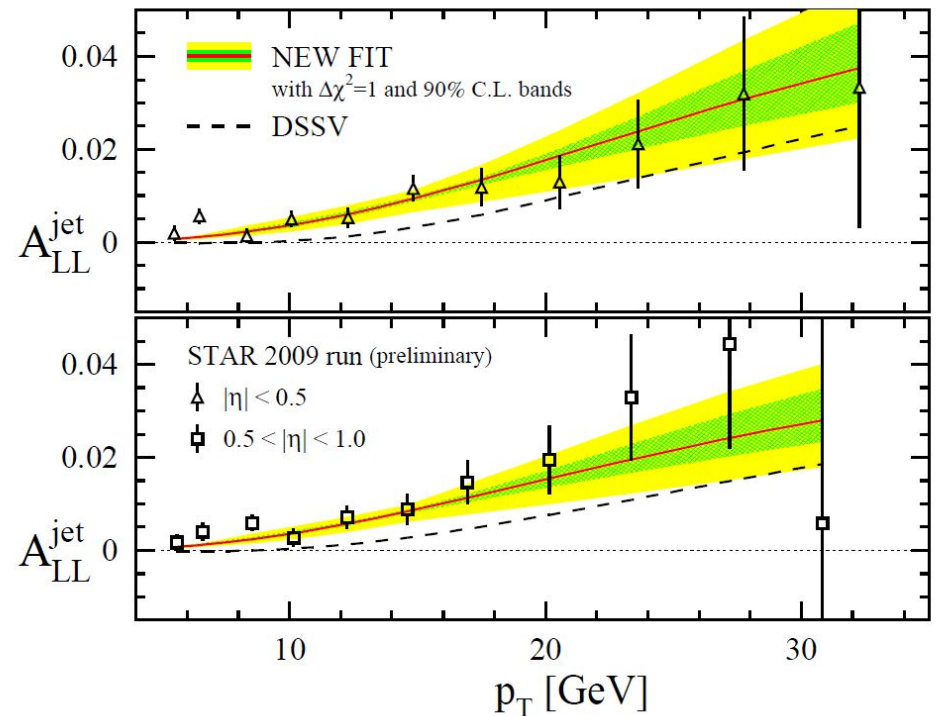

PRL 113, 012001 (2014)

# Unified View of Nucleon Structure

$W_p^u(x, k_T, \mathbf{r}_T)$  Wigner distributions

**5D Dist.**

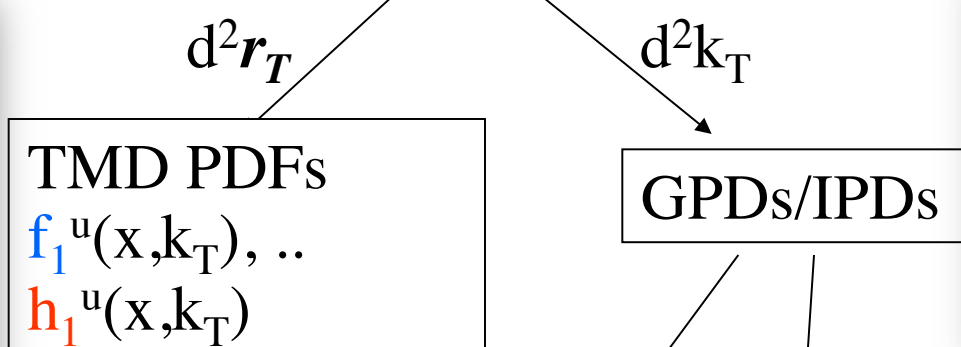
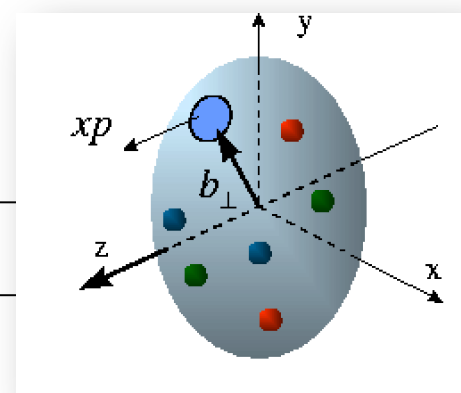
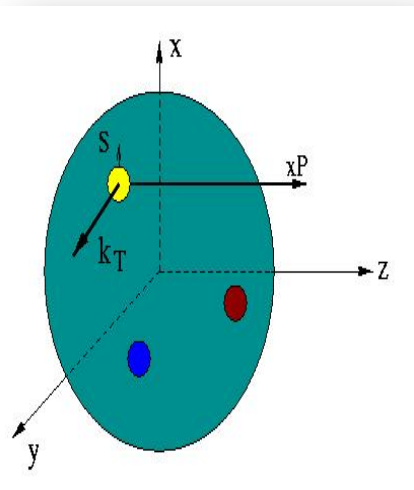

**3D imaging**

$dx$  & Fourier Transformation

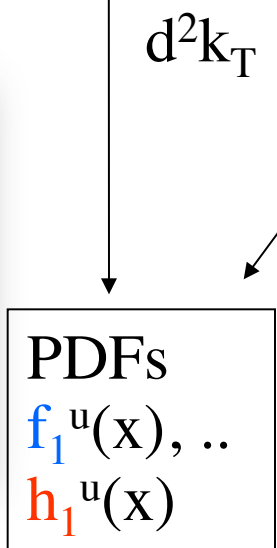
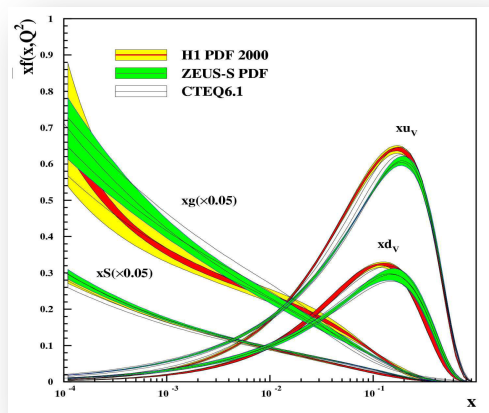



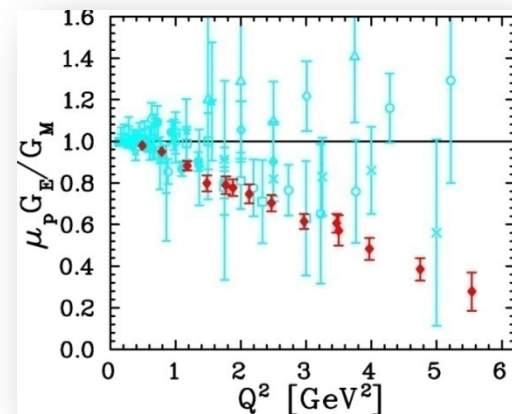
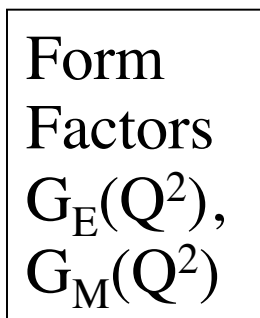

**1D**

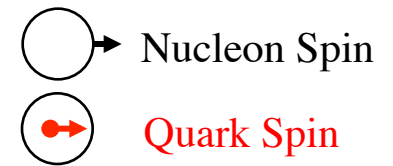

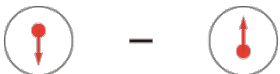
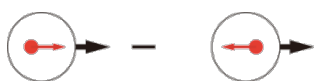
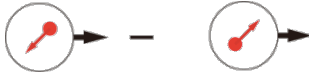

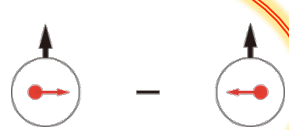



# Leading-Twist TMD PDFs

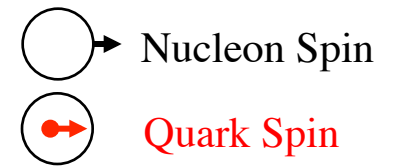

		Quark polarization		
		Unpolarized (U)	Longitudinally Polarized (L)	Transversely Polarized (T)
Nucleon Polarization	U	$f_1$ 		$h_1^\perp$  Boer-Mulders
	L		$g_1$  Helicity	$h_{1L}^\perp$  Long-Transversity
	T	$f_{1T}^\perp$  Sivers	$g_{1T}$  Trans-Helicity	$h_1$  Transversity $h_{1T}^\perp$  Pretzelosity

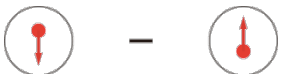
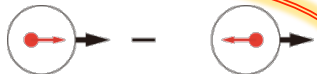
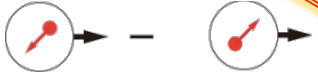
# Leading-Twist TMD PDFs



		Quark polarization		
		Unpolarized (U)	Longitudinally Polarized (L)	Transversely Polarized (T)
Nucleon Polarization	U	$f_1$ 		$h_1^\perp$  Boer-Mulders
	L		$g_1$  Helicity	$h_{1L}^\perp$  Long-Transversity
	T	$f_{1T}^\perp$  Sivers	$g_{1T}$  Trans-Helicity	$h_1$  Transversity $h_{1T}^\perp$  Pretzelosity

# Access TMDs through Hard Processes

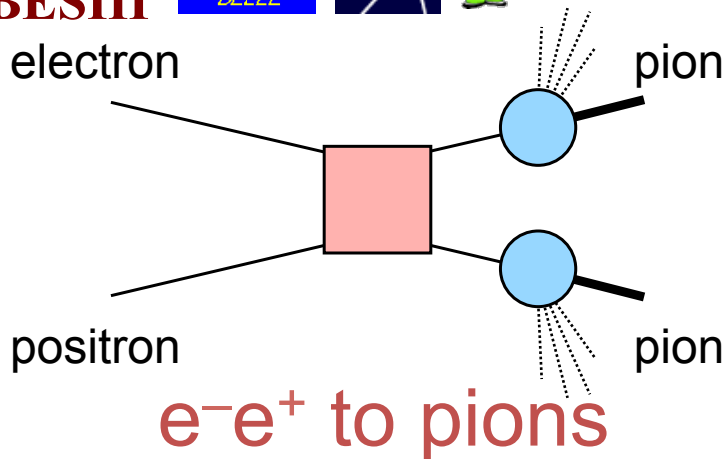
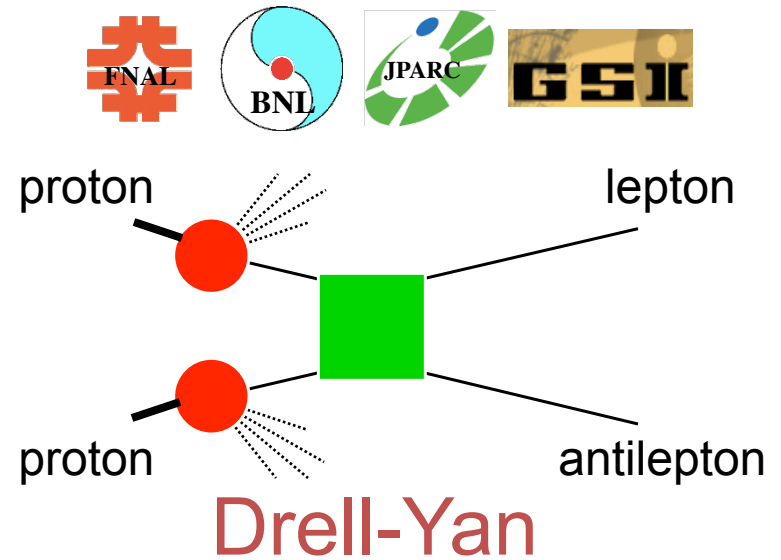
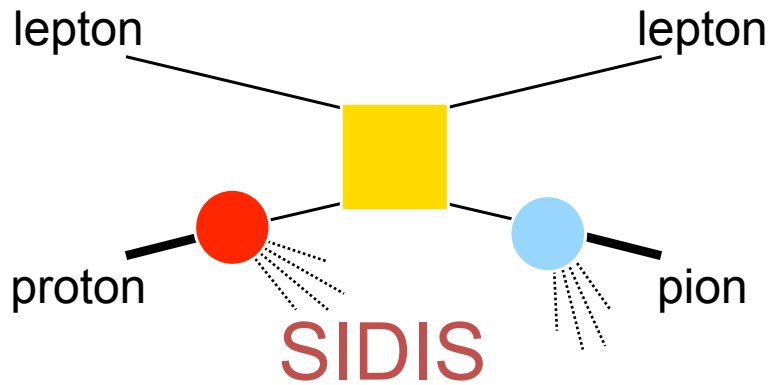

- Partonic scattering amplitude
- Fragmentation amplitude
- Distribution amplitude

$$f_{1T}^{\perp q}(\text{SIDIS}) = -f_{1T}^{\perp q}(\text{DY})$$

$$h_1^{\perp}(\text{SIDIS}) = -h_1^{\perp}(\text{DY})$$



# Access Parton Distributions through Semi-Inclusive DIS

$$\frac{d\sigma}{dx dy d\phi_S dz d\phi_h dP_{h\perp}^2} = \frac{\alpha^2}{xyQ^2} \frac{y^2}{2(1-\varepsilon)} \cdot$$

$f_1 = \odot$

Boer-Mulders

$h_1^\perp = \odot - \ominus$

$h_{1L}^\perp = \odot \rightarrow - \ominus \rightarrow$

Transversity

$h_{1T} = \odot - \ominus$

Sivers

$f_{1T}^\perp = \odot \uparrow - \ominus \downarrow$

Pretzelosity

$h_{1T}^\perp = \odot \uparrow - \ominus \uparrow$

$g_{1L} = \odot \rightarrow - \ominus \rightarrow$

$g_{1T} = \odot \uparrow - \ominus \uparrow$

$$\{F_{UU,T} + \dots$$

$$+ \varepsilon \cos(2\phi_h) \cdot F_{UU}^{\cos(2\phi_h)} + \dots$$

$$+ S_L [\varepsilon \sin(2\phi_h) \cdot F_{UL}^{\sin(2\phi_h)} + \dots]$$

$$+ S_T [\varepsilon \sin(\phi_h + \phi_S) \cdot F_{UT}^{\sin(\phi_h + \phi_S)}$$

$$+ \sin(\phi_h - \phi_S) \cdot (F_{UL}^{\sin(\phi_h - \phi_S)} + \dots)]$$

$$+ \varepsilon \sin(3\phi_h - \phi_S) \cdot F_{UT}^{\sin(3\phi_h - \phi_S)} + \dots]$$

$$+ S_L \lambda_e [\sqrt{1-\varepsilon^2} \cdot F_{LL} + \dots]$$

$$+ S_T \lambda_e [\sqrt{1-\varepsilon^2} \cos(\phi_h - \phi_S) \cdot F_{LT}^{\cos(\phi_h - \phi_S)} + \dots]\}$$

Unpolarized

Polarized  
Target

Polarized  
Beam and  
Target

$S_L, S_T$ : Target Polarization;  $\lambda_e$ : Beam Polarization

# Separation of Collins, Sivers and pretzelosity effects through angular dependence

$$\begin{aligned}
 A_{UT}(\varphi_h^l, \varphi_S^l) &= \frac{1}{P} \frac{N^\uparrow - N^\downarrow}{N^\uparrow + N^\downarrow} \\
 &= A_{UT}^{\text{Collins}} \sin(\phi_h + \phi_S) + A_{UT}^{\text{Sivers}} \sin(\phi_h - \phi_S) \\
 &+ A_{UT}^{\text{Pretzelosity}} \sin(3\phi_h - \phi_S)
 \end{aligned}$$

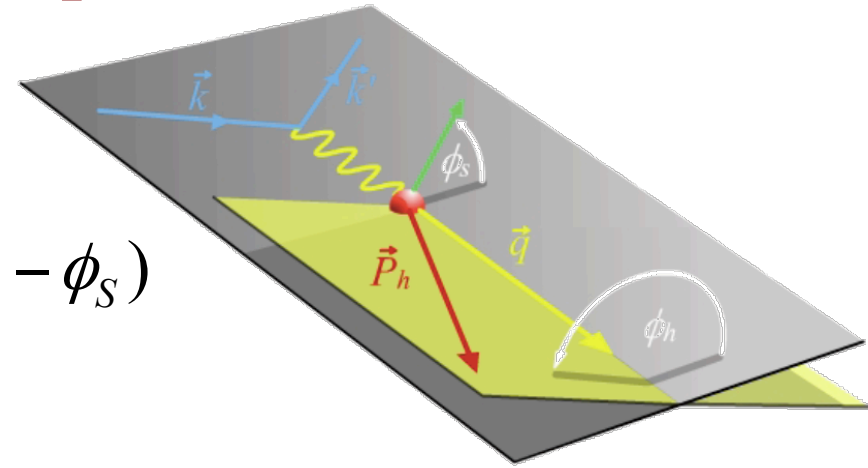

$$A_{UT}^{\text{Collins}} \propto \langle \sin(\phi_h + \phi_S) \rangle_{UT} \propto h_1 \otimes H_1^\perp \quad \leftarrow \text{Collins frag. Func. from } e^+e^- \text{ collisions}$$

$$A_{UT}^{\text{Sivers}} \propto \langle \sin(\phi_h - \phi_S) \rangle_{UT} \propto f_{1T}^\perp \otimes D_1$$

$$A_{UT}^{\text{Pretzelosity}} \propto \langle \sin(3\phi_h - \phi_S) \rangle_{UT} \propto h_{1T}^\perp \otimes H_1^\perp$$

SIDIS SSAs depend on 4-D variables ( $x$ ,  $Q^2$ ,  $z$  and  $P_T$ )

Large angular coverage and precision measurement of asymmetries in 4-D phase space is essential.

# E06-010: neutron $A_{(U/L)T}(\pi^+K^+, \pi^-K^-)$

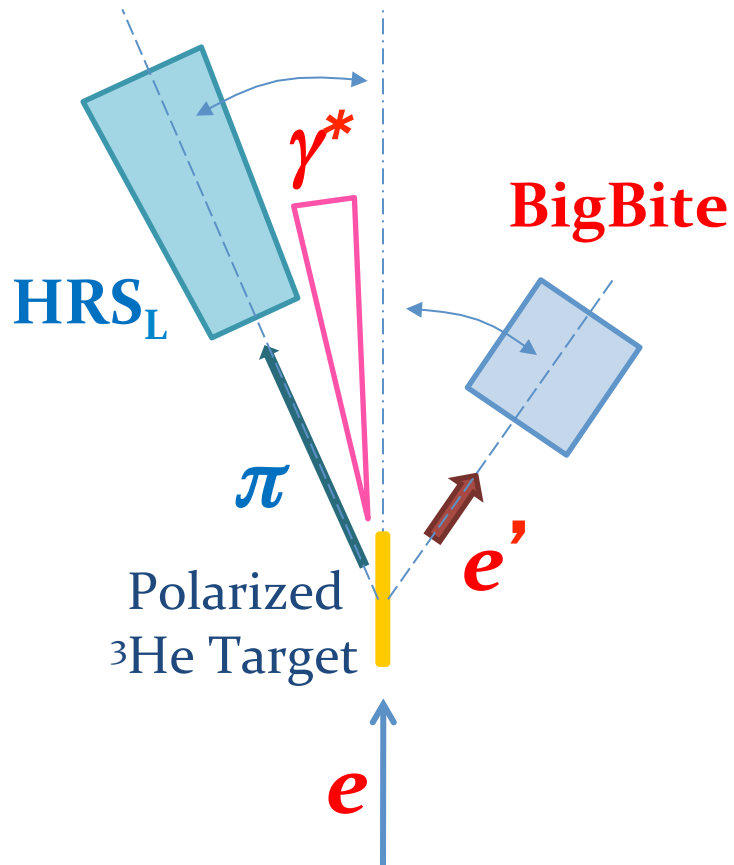

- **First neutron** data in SIDIS SSA&DSA
  - Similar  $Q^2$  as HERMES experiment
- Disentangle Collins/Sivers effects
- Electron beam:  $E = 5.9$  GeV
  - High luminosity  $L \sim 10^{36} \text{ cm}^{-2}\text{s}^{-1}$
  - 40 cm transversely polarized  $^3\text{He}$  target
    - Average beam current 12  $\mu\text{A}$  (max: 15  $\mu\text{A}$  as in proposal)
- BigBite at  $30^\circ$  as **electron** arm:  
 $P_e = 0.6 \sim 2.5 \text{ GeV}/c$
- HRS<sub>L</sub> at  $16^\circ$  as **hadron** arm:  
 $P_h = 2.35 \text{ GeV}/c$

# Results on Neutron

- Sizable Collins  $\pi^+$  asymmetries at  $x=0.34$ ?
  - Sign of violation of Soffer's inequality?
  - **Data are limited by stat. Needs more precise data!**

- Negative Sivers  $\pi^+$  Asymmetry
  - Consistent with HERMES/COMPASS

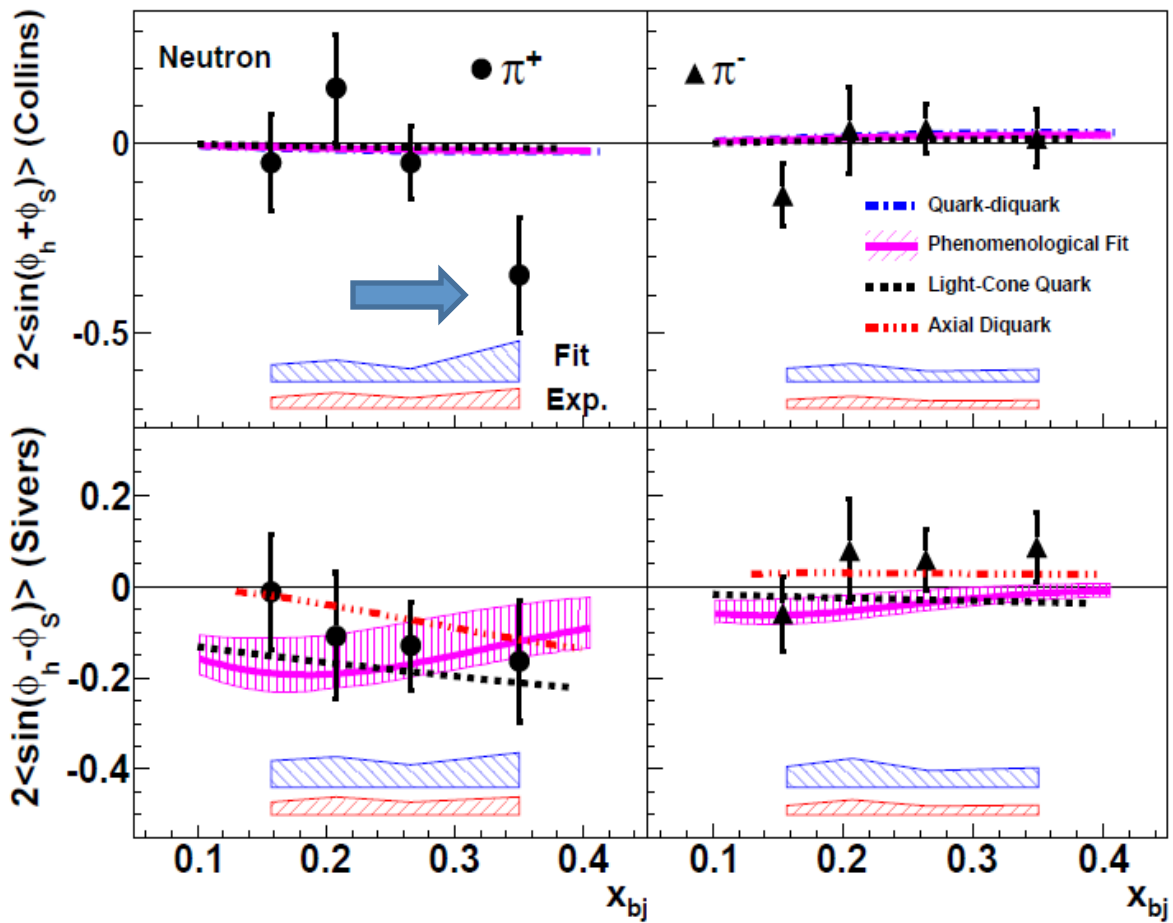

- **demonstration of negative d quark Sivers function.**

**Model (fitting) uncertainties shown in blue band.**  
 Experimental systematic uncertainties: red band  
 X. Qian *et al*, Phys. Rev. Lett. 107, 072003 (2011)

# Double Spin Asymmetry: $g_{1T}$

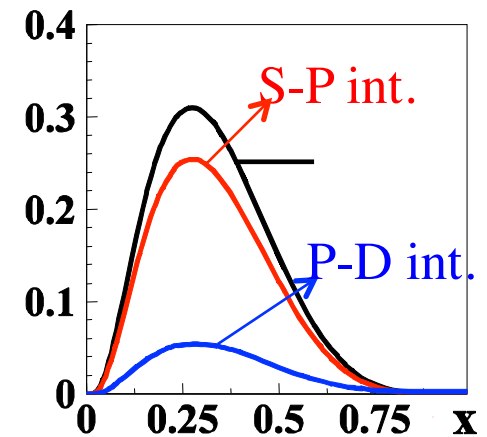
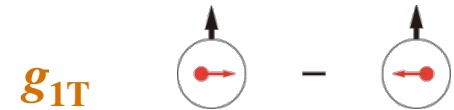
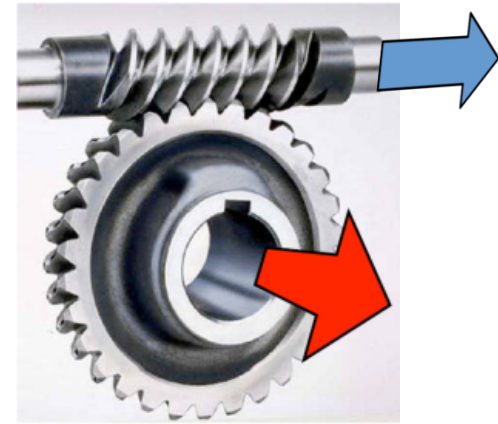

Light-Cone CQM by B. Pasquini  
B.P., Cazzaniga, Boffi, PRD78, 2008

- $A_{LT}^{\cos(\varphi_h - \varphi_s)} \propto g_{1T}^q \otimes D_{1q}^h$

- Leading twist TMD PDFs
- T-even, Chiral-even

- Dominated by **real** part of interference between **L=0 (S)** and **L=1 (P)** states

- Imaginary part -> Sivers effect

- First TMDs in Pioneer Lattice calculation

- arXiv:0908.1283 [hep-lat], Europhys.Lett.88:61001,2009
- arXiv:1011.1213 [hep-lat], Phys.Rev.D83:094507,2011

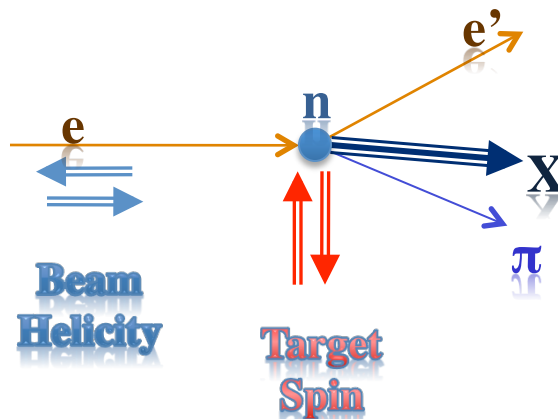

# New Observable Reveals Interesting Behaviors of Quarks

$$A_{LT}^{\cos(\varphi_h - \varphi_s)} \propto g_{1T}^q \otimes D_{1q}^h$$

Target:  
polarized  $^3\text{He} \Rightarrow$  polarized  
neutron

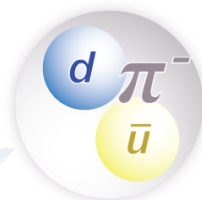
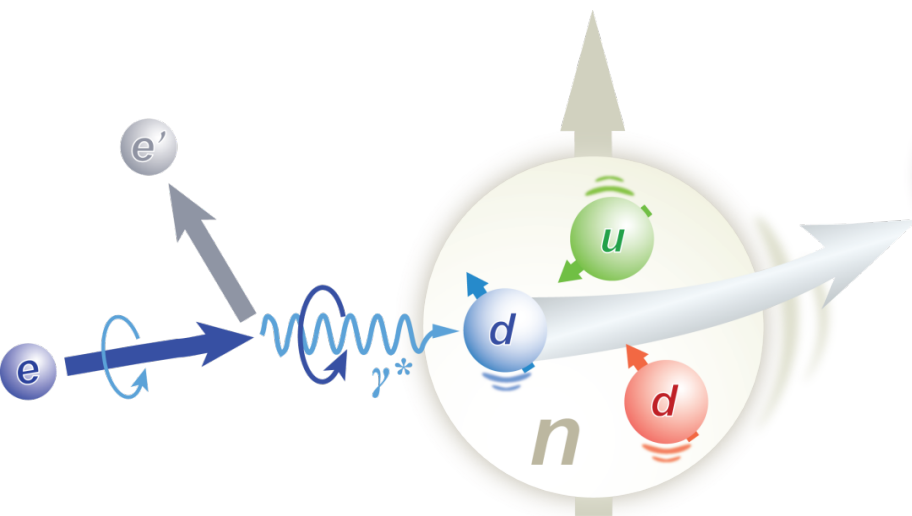
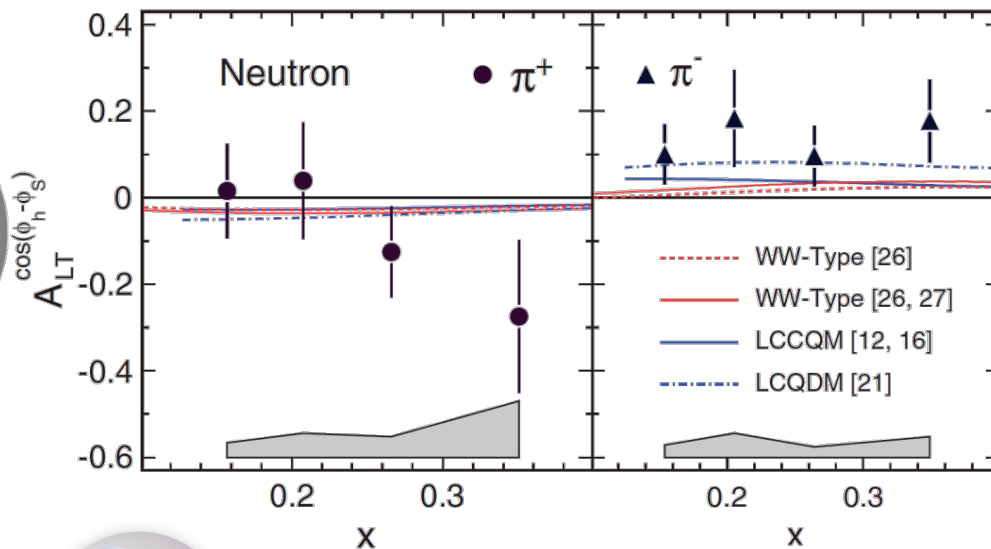
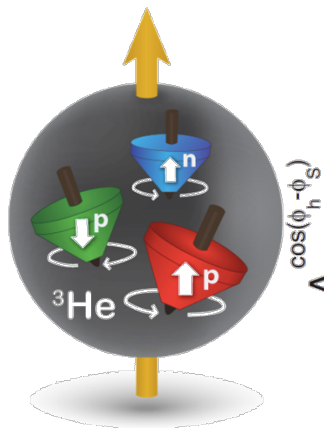

First measurement of  $A_{LT}$   
beam-target double-spin asymmetry

## Indications:

- A non-vanishing quark “transversal helicity” distribution, reveals alignment of quark spin transverse to neutron spin direction
- Quark orbital motions

J. Huang et al., PRL108, 052001 (2012)

# SoLID-Spin: SIDIS on $^3\text{He}$ /Proton @ 11 GeV

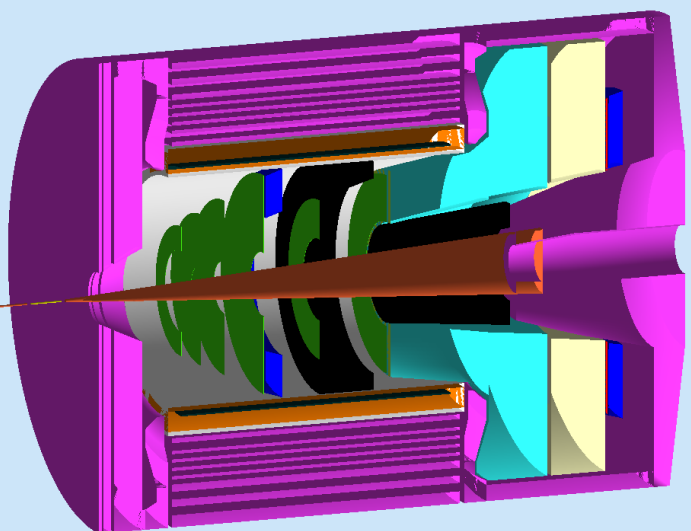

**E12-10-006:** Single Spin Asymmetry on Transverse  $^3\text{He}$  @ 90 days, **rating A**

**E12-11-007:** Single and Double Spin Asymmetry on  $^3\text{He}$  @ 35 days, **rating A**

**E12-11-108:** Single and Double Spin Asymmetries on Transverse Proton @ 120 days, **rating A**

Sivers  $\pi^-$  @  $z = 0.55$

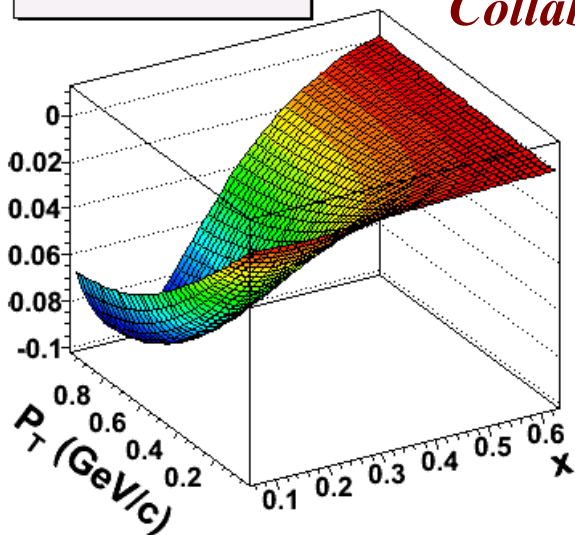

*International collaboration with 200 Collaborators from 11 countries*

Key of SoLID-Spin program:  
 Large Acceptance  
 + High Luminosity  
 → 4-D mapping of asymmetries  
 → Tensor charge, TMDs ...  
 → Lattice QCD, QCD Dynamics, Models.

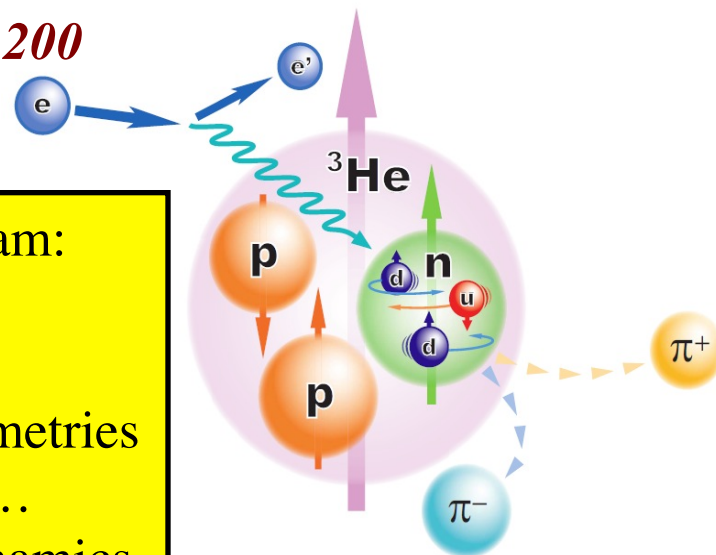

## ***Experiment E12-10-006***

# ***Nucleon Transversity at 11 GeV Using a Polarized <sup>3</sup>He Target and SoLID in Hall A***

**PKU., CalState-LA, CIAE, W&M, Duke, FIU, Hampton, Huangshan U.,  
Cagliari U. and INFN, Huazhong Univ. of Sci. and Tech., INFN-Bari and U. of Bari,  
INFN-Frascati, INFN-Pavia, Torino U. and INFN, JLab, JSI (Slovenia), Lanzhou U,  
LBNL, Longwood U, LANL, MIT, Miss. State, New Mexico, ODU, Penn State at Berks,  
Rutgers, Seoul Nat. U., St. Mary's, Shandong U., Syracuse, Tel aviv, Temple,  
Tsinghua U, UConn, Glasgow, UIUC, Kentucky, Maryland, UMass,  
New Hampshire, USTC, UVa  
*and the Hall A Collaboration***

***Strong theory support, Over 200 collaborators, 50+ institutions,  
11 countries, strong overlap with PVDIS Collaboration***



# 3-D neutron $\pi^+/\pi^-$ Collins/Sivers Asymmetries at $Q^2=2.0 \text{ GeV}^2$

Collins/Sivers asymmetries vs.  $x$  and transverse momentum  $P_T$  at different  $z$  at fixed  $Q^2$ .

Multi-dimensional nature.

Targets:  $^3\text{He}$  (neutron), and H/D (factorization)

Detect: positive pion and negative pions!

Sivers  $\pi^+$  @  $z = 0.35$

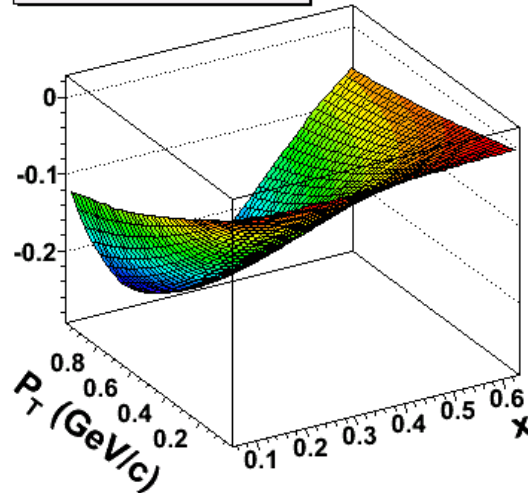

Collins  $\pi^+$  @  $z = 0.45$

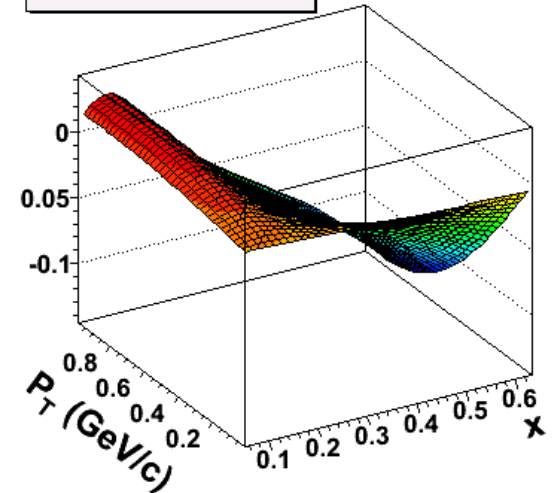

Sivers  $\pi^-$  @  $z = 0.55$

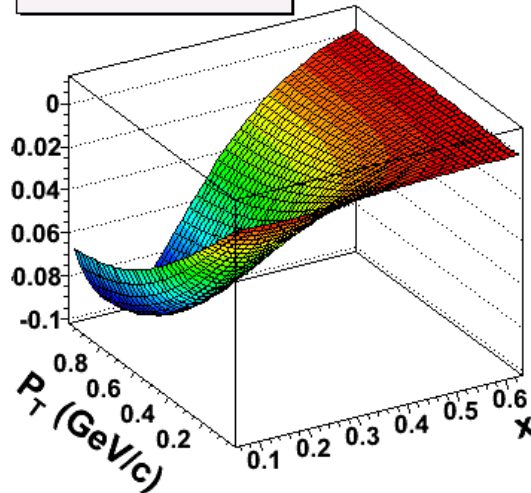

Collins  $\pi^-$  @  $z = 0.65$

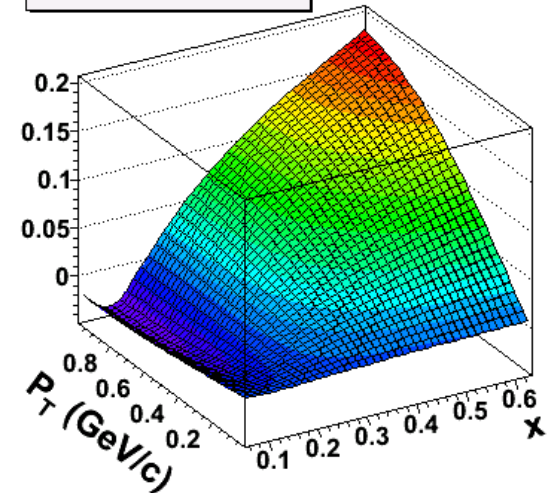

# Projected Data (E12-10-006)

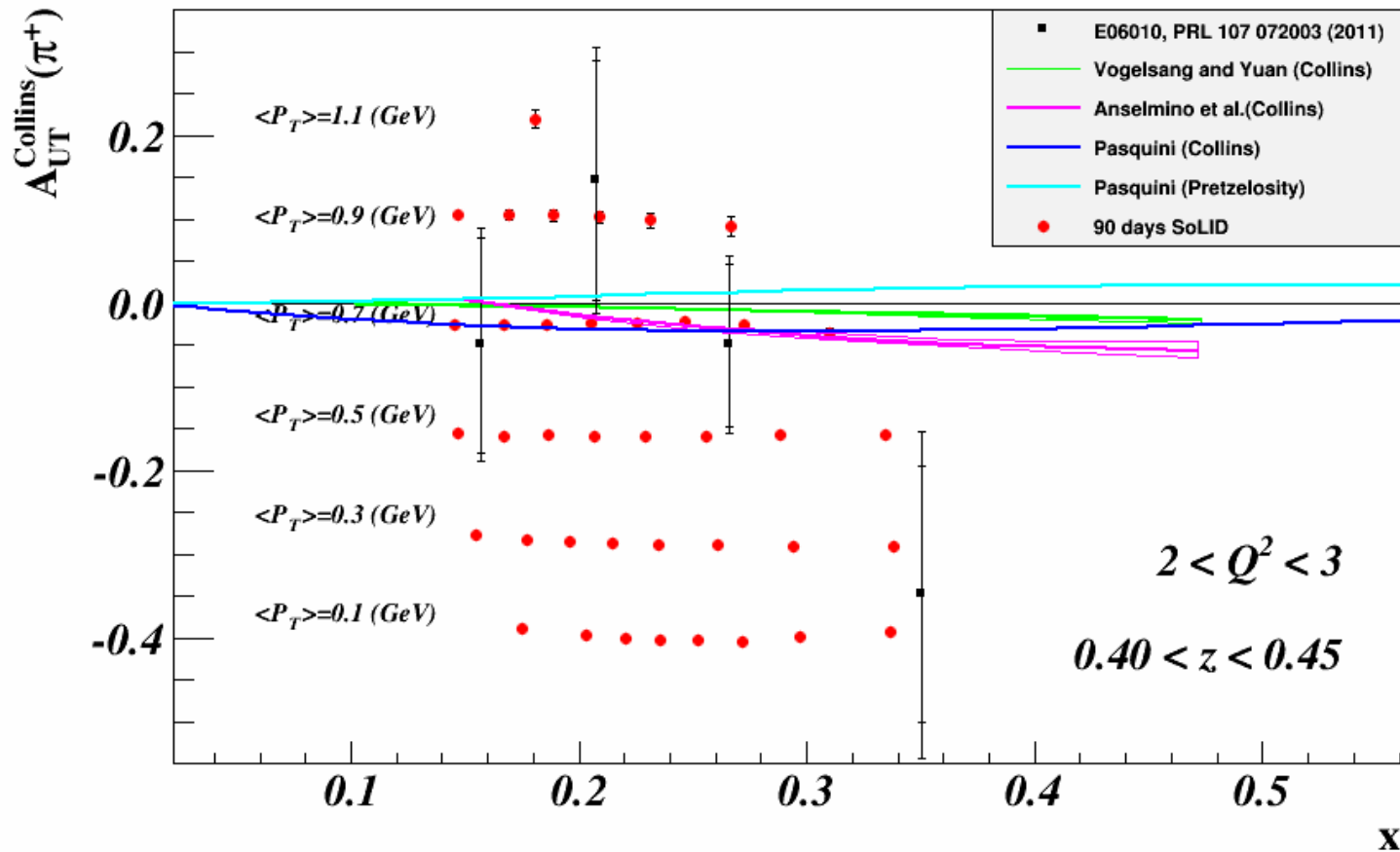

- $z$  ranges from 0.3 ~ 0.7, only **one  $z$  and  $Q^2$  bin** of 11/8.8 GeV is shown here.  $\pi^+$  projections are shown, similar to the  $\pi^-$ .

E12-10-006 Spokespersons: Chen, Gao (contact), Jiang, Qian and Peng

# Power of SOLID (example)

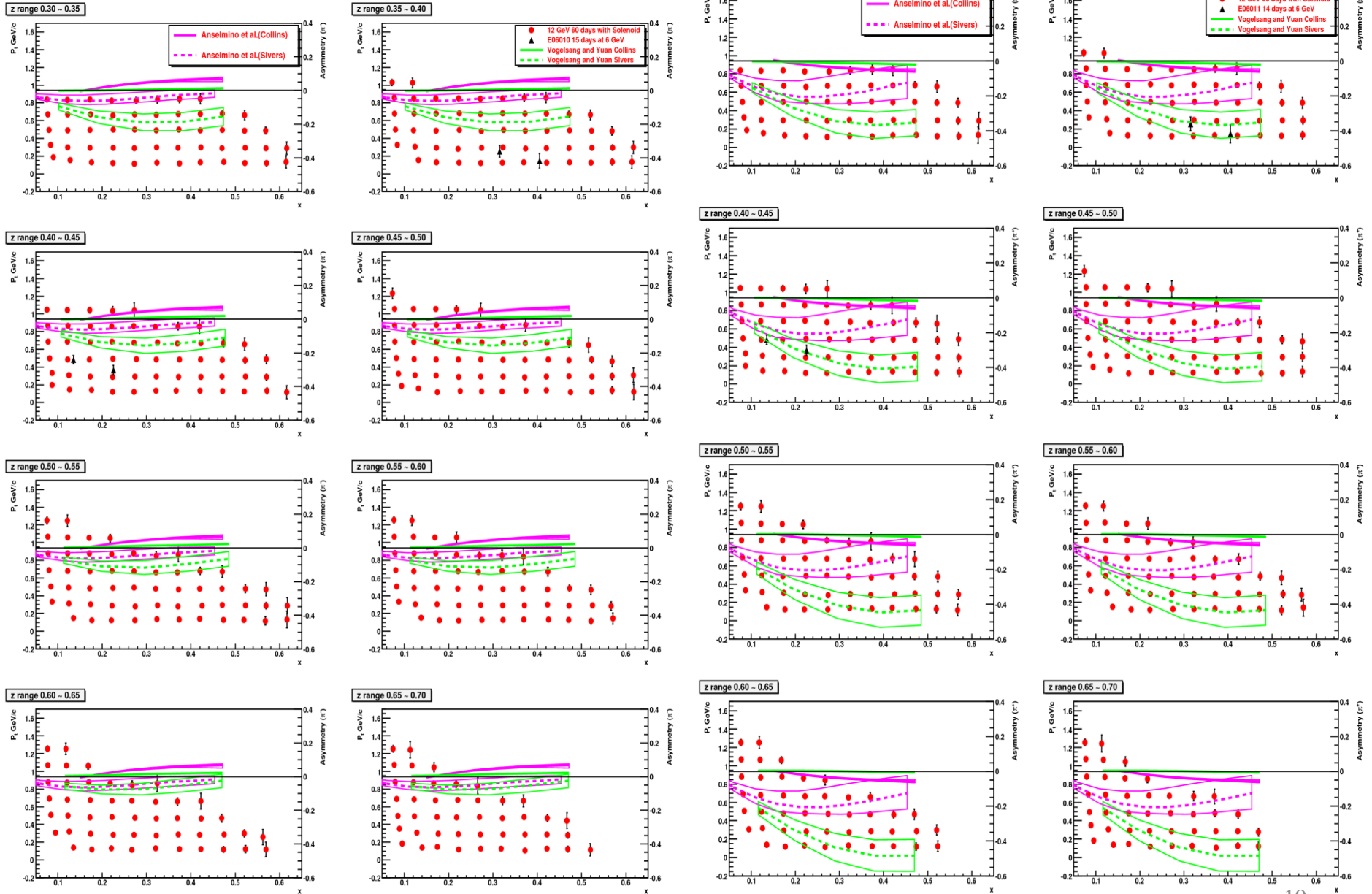

# SoLID E12-11-007 Projection for $A_{LT}$ (Partial)

- E12-11-007 and E12-10-006:  
Neutron  $A_{LT}$  Projection of one out of 48  $Q^2$ - $z$  bins for  $\pi^-$

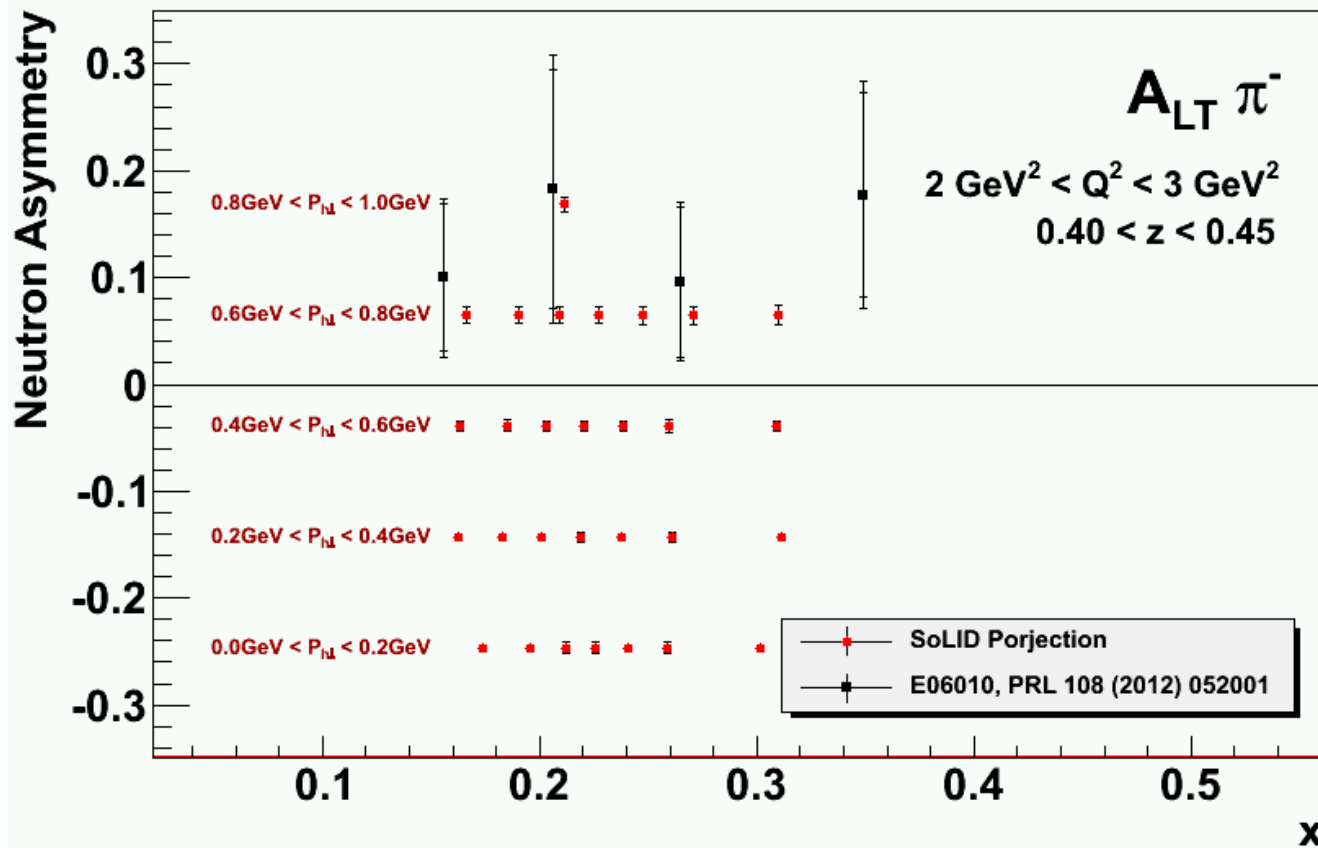

E12-11-007 spokespersons: J.P. Chen, J. Huang, Yi Qiang, W.B. Yan (USTC)  
E06010 Results, J. Huang et al., PRL108, 052001 (2012)

# SoLID E12-11-007 Projection/ $A_{UL}$ (Partial)

- Projection of a single  $Q^2$ - $z$  bin for  $\pi^+$

(one out of 48  $Q^2$ - $z$  bins)

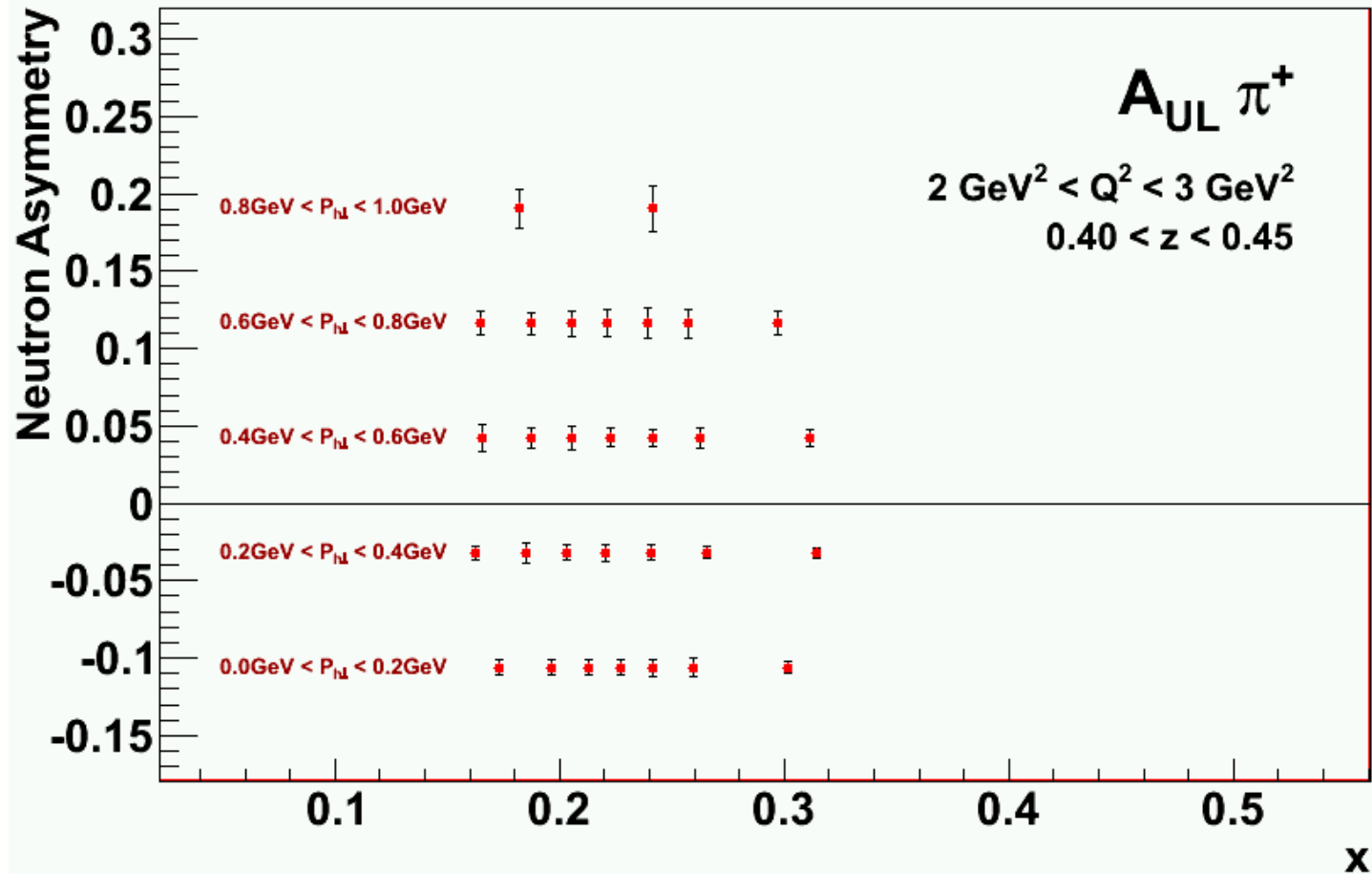

# SoLID E12-11-007 Projection/ $A_{UL}$ (Partial)

- Projection of a single  $Q^2$ - $z$ - $PT$  bin for  $\pi^+$  (no existing measurement)  
And compared to model predictions for SoLID kinematics

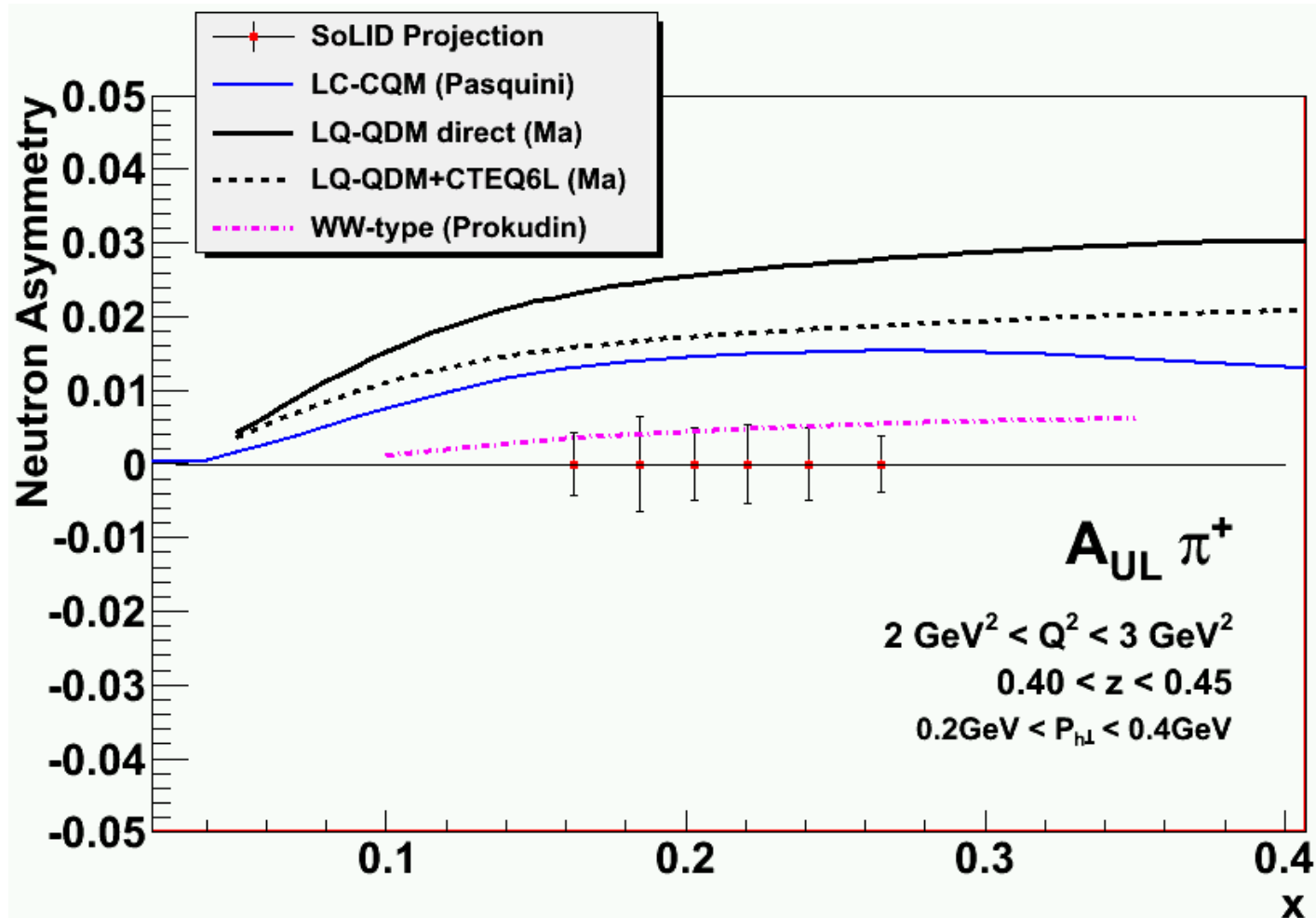

# Experiment E12-11-108:

## Target Single Spin Asymmetry in SIDIS ( $e, e\pi^\pm$ ) Reaction on a Transversely Polarized Proton Target and SoLID

- Measure SSA in SIDIS using transversely polarized proton target
  - Use similar detector setup as that of two approved  $^3\text{He}$  SoLID expts.
  - Use JLab/UVA polarized  $\text{NH}_3$  target with upgraded design of the magnet
  - Target spin-flip every two hours with average in-beam polarization of 70%
  - Two Beam energies: 11 GeV and 8.8 GeV
  - Polarized luminosity with 100nA current:  $10^{35} \text{ cm}^{-2}\text{s}^{-1}$
  - Beamline chicane to transport beam through 5T target magnetic field (already used for g2p expt.)

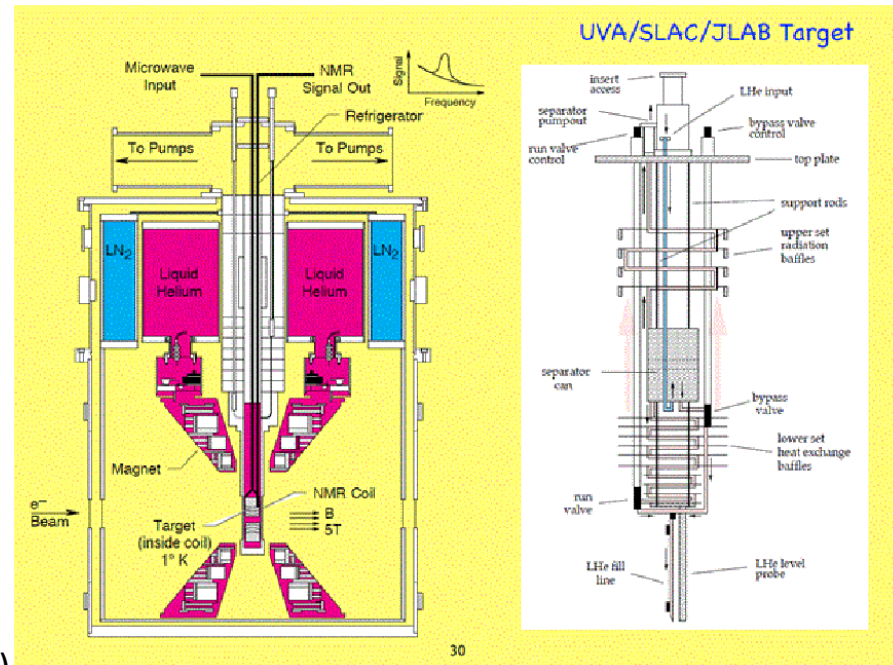

**Spokespersons: K. Allada (Jlab), J. P. Chen (Jlab), Haiyan Gao (Contact), Xiaomei Li (CIAE), Z-E. Meziani (Temple)**

# Proton 4-D Projection

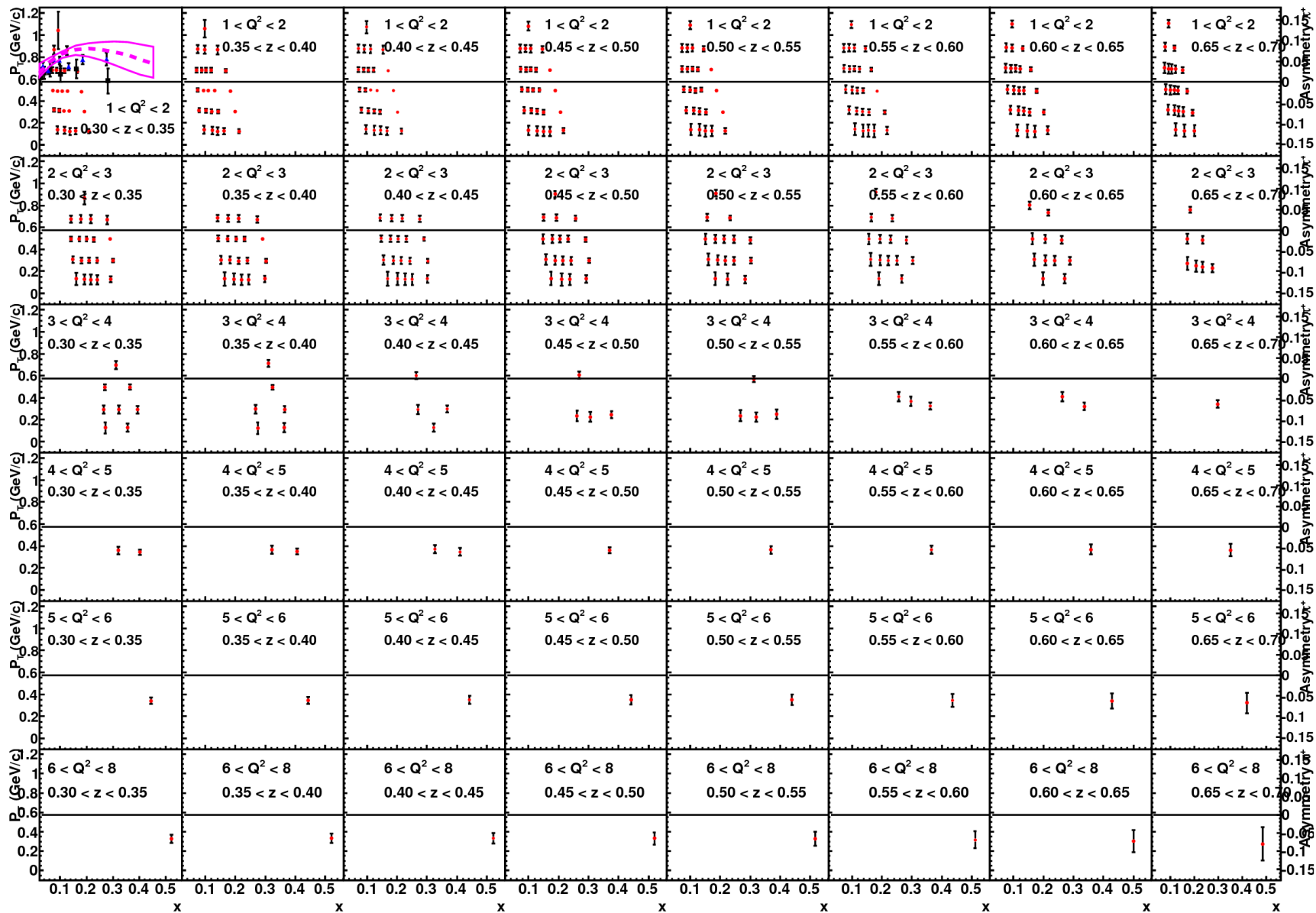



# Projected measurements in 1-D (x)

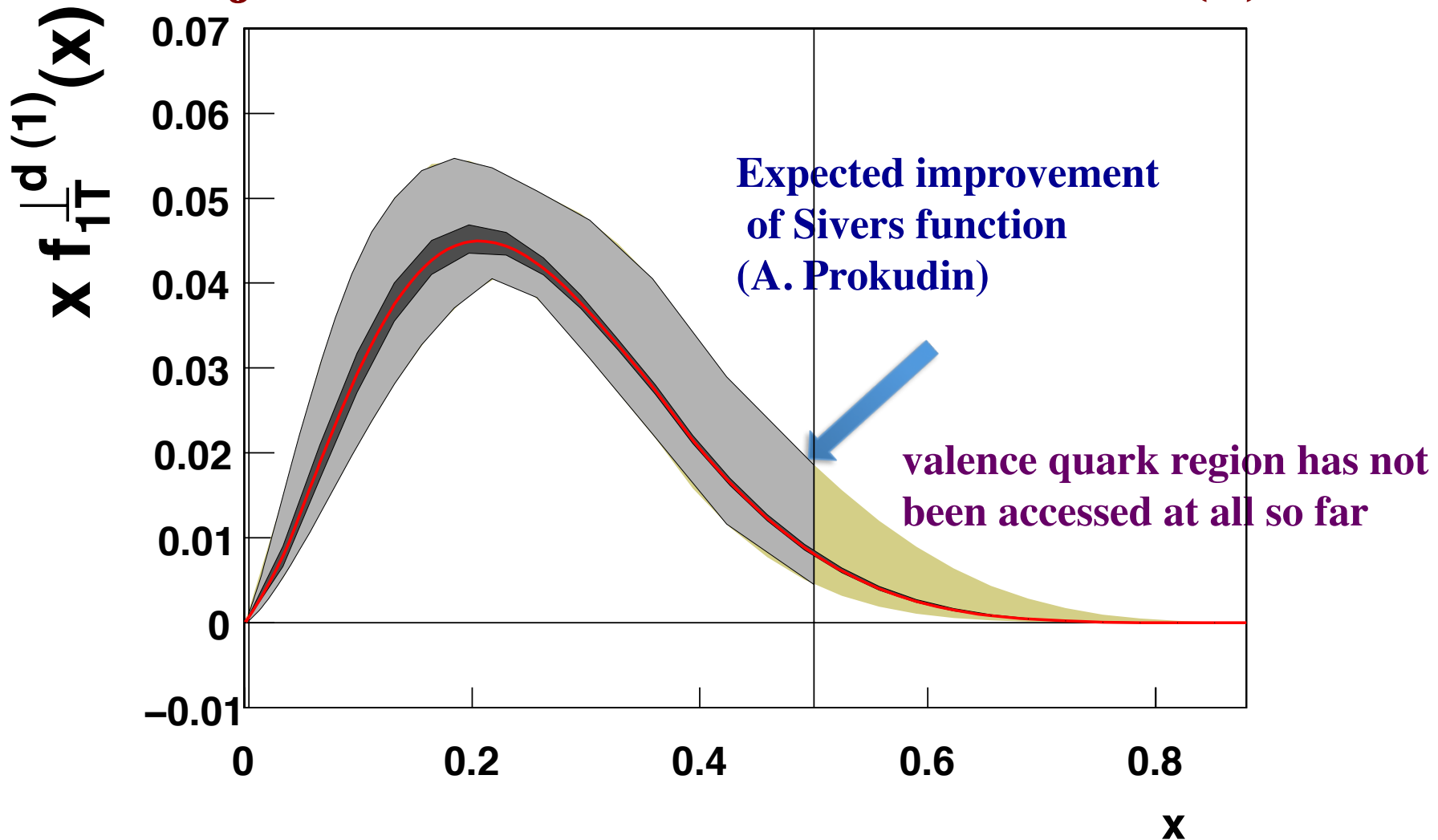

Assumption: We know the  $k_T$  dependence,  $Q^2$  evolution of TMDs.  
Also knowledge on TMFF  $\rightarrow$  project onto 1-D in  $x$  to illustrate the power of SoLID- $^3\text{He}$ .

# Transversity

$$h_{1T} = \begin{array}{c} \uparrow \\ \circ \\ \downarrow \end{array} - \begin{array}{c} \uparrow \\ \circ \\ \uparrow \end{array}$$

- Lowest moment gives tensor charge

$$\delta q^a = \int_0^1 (h_{1T}^a(x) - h_{1T}^{\bar{a}}(x)) dx$$

- Fundamental property, benchmark test of Lattice QCD

●  $\delta u = 0.39^{+0.18}_{-0.12}$

●  $\delta d = -0.25^{+0.30}_{-0.10}$

▲  $\delta u = 0.31^{+0.16}_{-0.12}$

▲  $\delta d = -0.27^{+0.10}_{-0.10}$

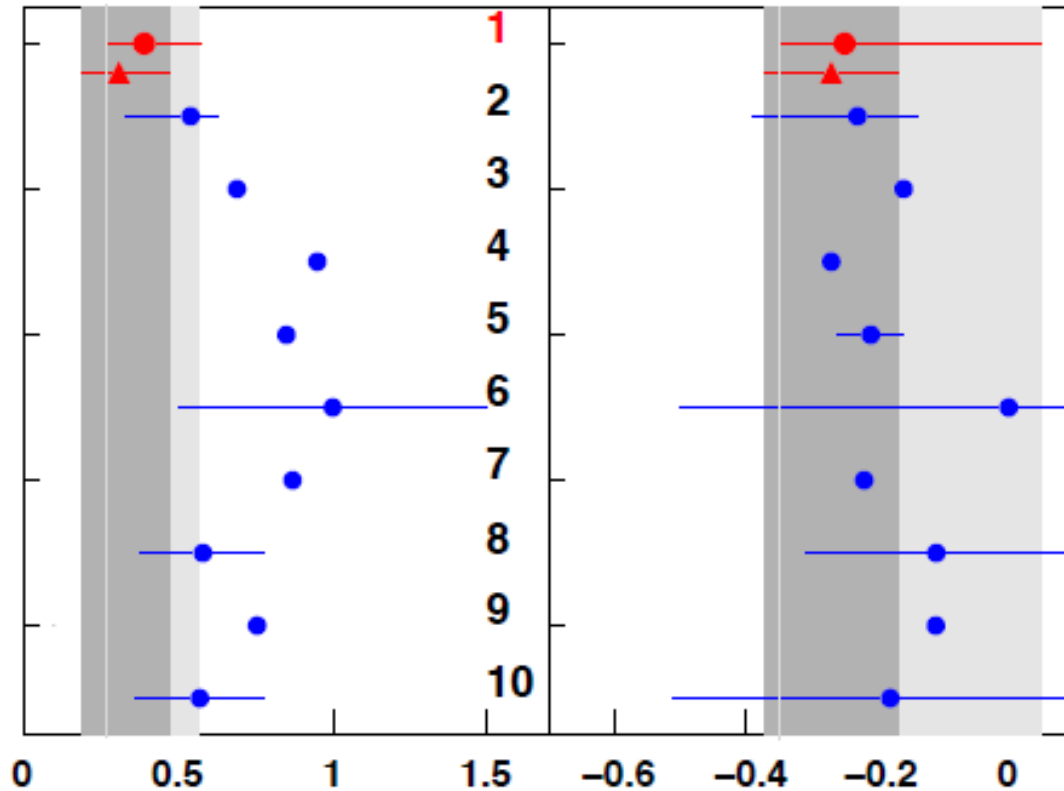

# Transversity and Tensor Charge

- Collins Asymmetries  $\sim$  Transversity (x) Collin Function
- Transversity**: chiral-odd, not couple to gluons, **valence behavior**, largely unknown
- Tensor charge (0th moment of transversity): fundamental property**  
Lattice QCD, Bound-State QCD (Dyson-Schwinger) , Light-cone Quark Models, ...
- Global model fits to experiments (SIDIS and e+e-)
- SoLID** with **trans polarized n & p**  $\rightarrow$  determination of tensor charges for **d & u**

## Collins Asymmetries

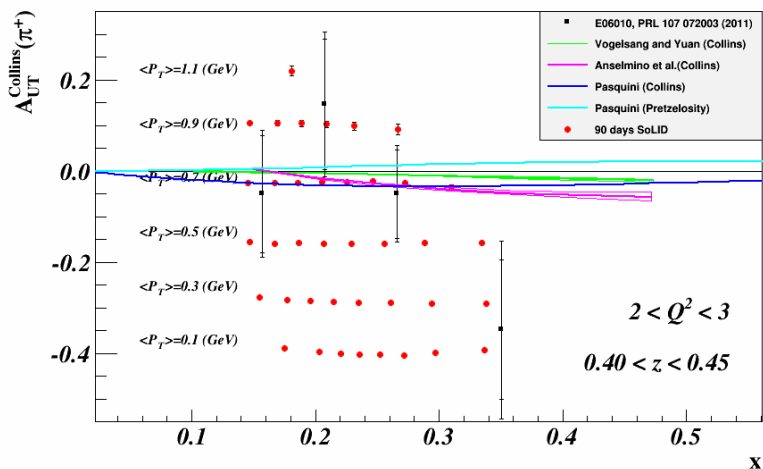

## Tensor Charges

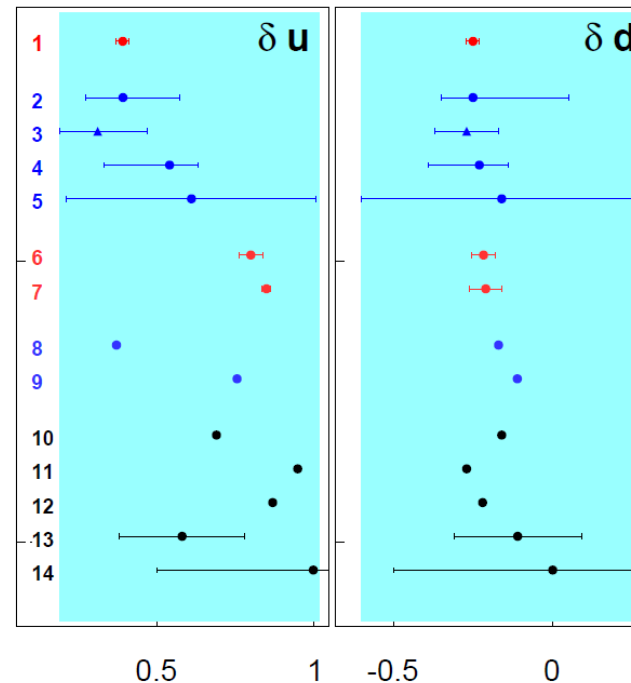

1 - 12 GeV SoLID (projection)

Extractions from experiments:

2,3 - Anselmino et al, Phys.Rev. D87 (2011)

4 - Anselmino et al, Nucl. Phys. Proc. Suppl.

5 - Bacchetta, Courtoy, Radici, JHEP 130

Lattice QCD:

6 - Alexandrou et al, PoS(LATTICE 2014)

7 - Gockeler et al, Phys. Lett. B (2005)

DSE:

8 - Pitschmann et al, (2014)

9 - Hecht, Roberts and Schmidt, Phys. Rev. D (2007)

Models:

10 - Cloet, Bentz and Thomas, Phys. Lett. B (2007)

11 - Wakamatsu, Phys. Lett. B (2007)

12 - Pasquini et al, Phys. Rev. D (2007)

13 - Gamberg and Goldstein, Phys. Rev. D (2007)

14 - He and Ji, Phys. Rev. D (1995)

# TMDs: 3-d Structure, Quark Orbital Motion

- TMDs : Correlations of transverse motion with quark spin and orbital motion
- **Without OAM, off-diagonal TMDs=0,**  
no direct model-independent relation to the OAM in spin sum rule yet
- Sivers Function: QCD lensing effects
- In a large class of models, such as light-cone quark models
  - Pretzelosity:  $\Delta L=2$  (L=0 and L=2 interference , L=1 and -1 interference)**
  - Worm-Gear:  $\Delta L=1$  (L=0 and L=1 interference)**
- **SoLID with trans polarized n/p** → quantitative knowledge of OAM

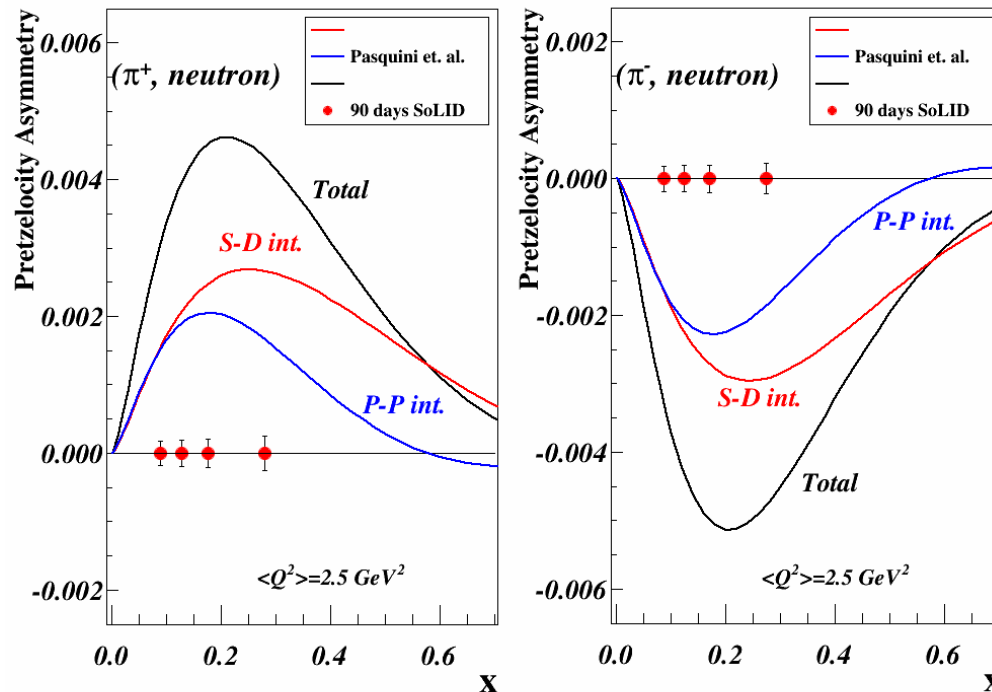

# Summary

- **Frontiers in nucleon structure go beyond collinear, 1-D picture**
  - **TMDs**
    - **Three-dimensional description of nucleon in momentum space**
    - **Quantitative information about orbital motion (orbital angular momentum)**
    - **Transverse motion: spin-orbit correlations, multi-parton correlations, dynamics of confinement and QCD**
    - **10% quark tensor charge from both SSA data from SoLID provides excellent test of LQCD predictions**
- **JLab 12-GeV upgrade will provide excellent opportunities to map out the 3-dimensional structure of the nucleon through TMDs and GPDs**

**Supported in part by U.S. Department of Energy under contract number DE-FG02-03ER41231**