

fiber reflectivity test

Chendi Shen

2018.6.7

Test setup

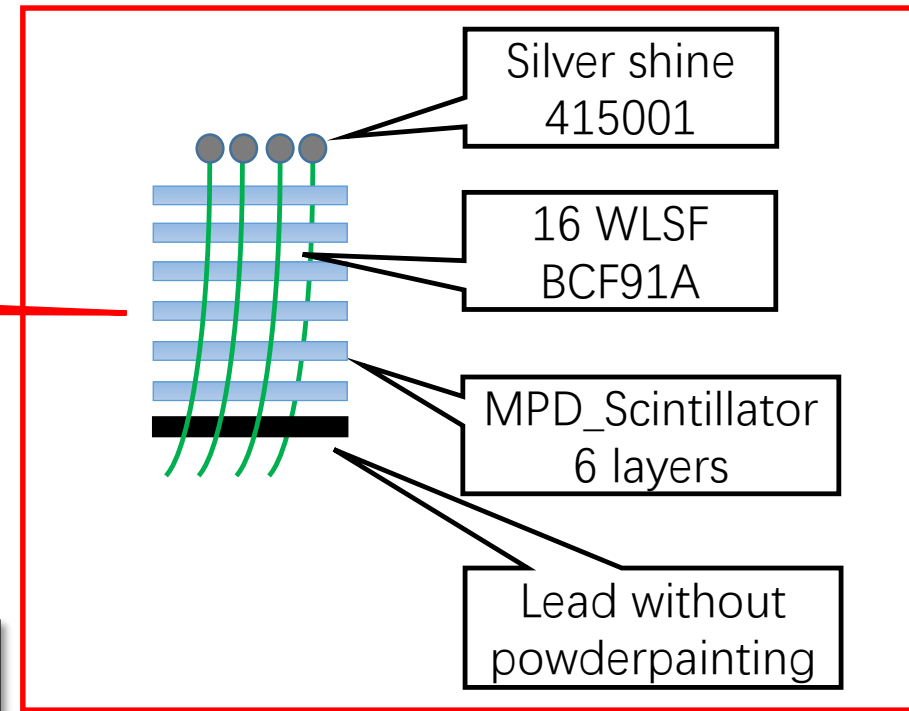
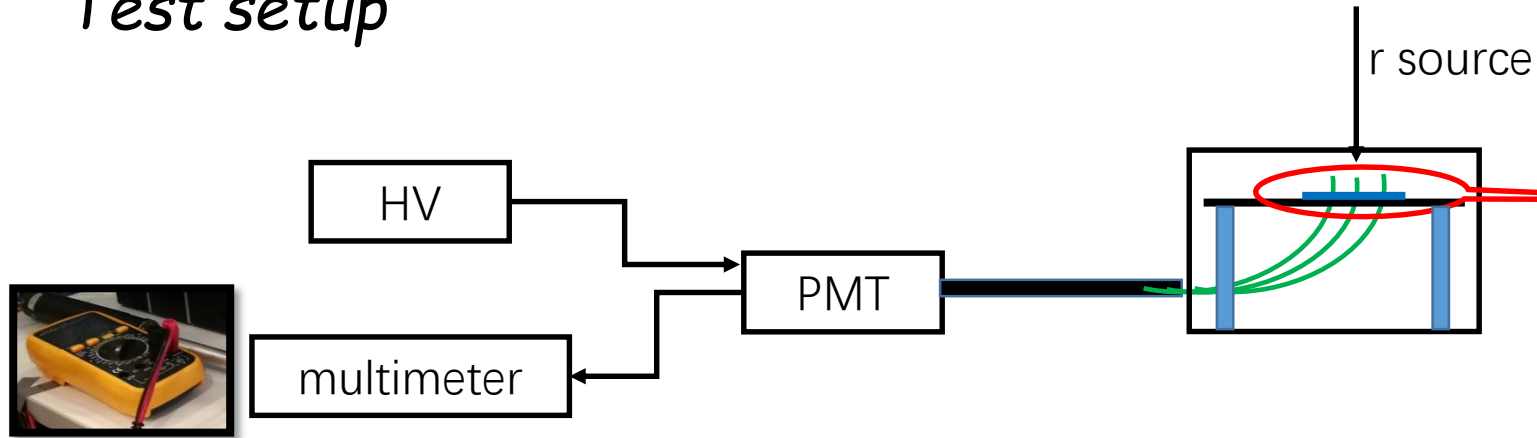

r source

Test box

Test box



Test box

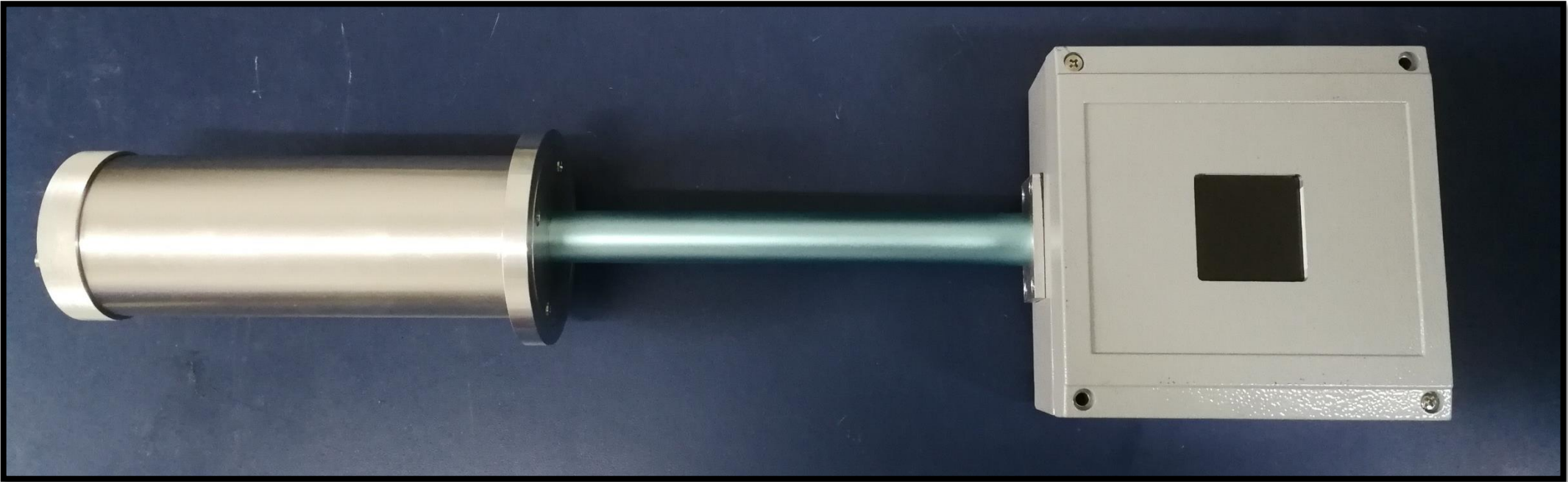
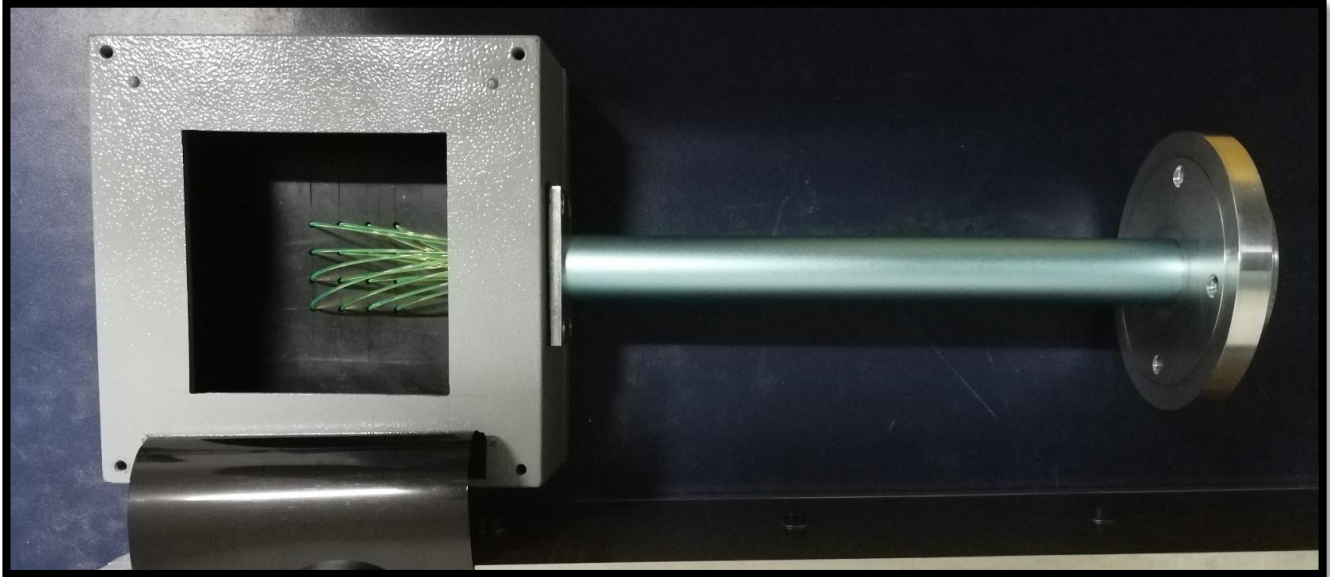
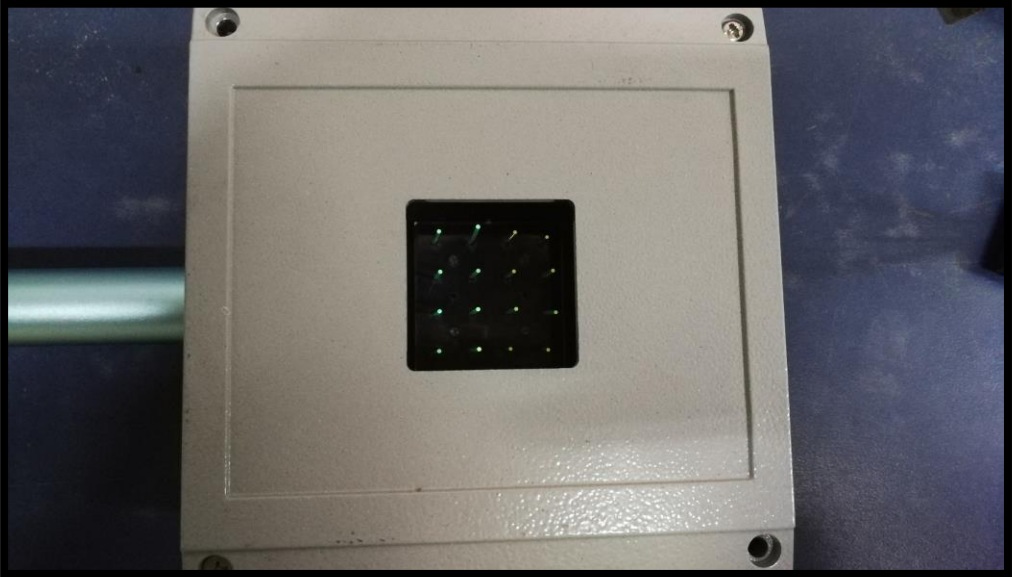

Test result

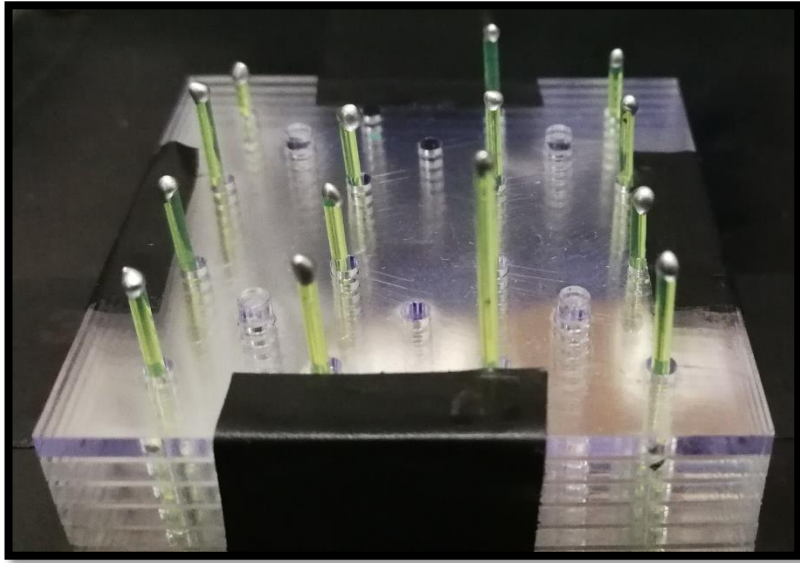

	BCF91A Voltage (mV)
No mirror painting	640
Silver 415001	890
improvement	39%

Previous test results 03/16/2017 Weekly meeting

	BCF91A Npe	Y11 Npe
No mirror painting	24	25
Silver 415001	34	33
improvement	41.67%	32%

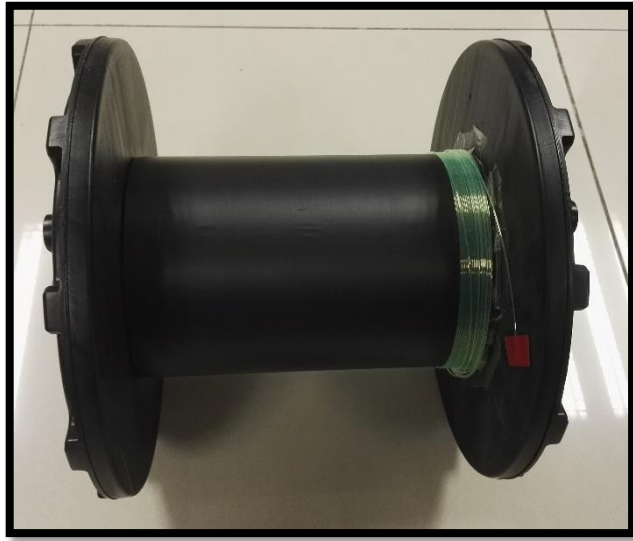

Y11



BCF91A

Next to do

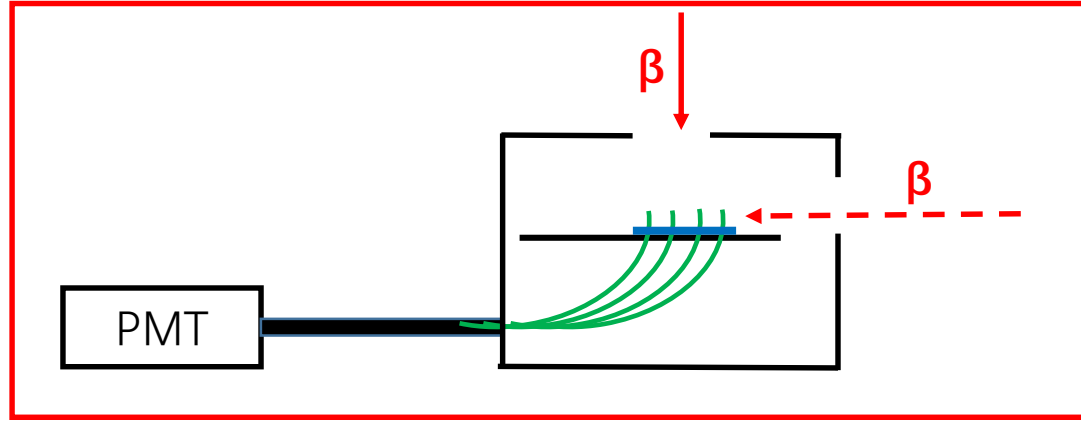

- Different reflective materials on the end of the fibers.

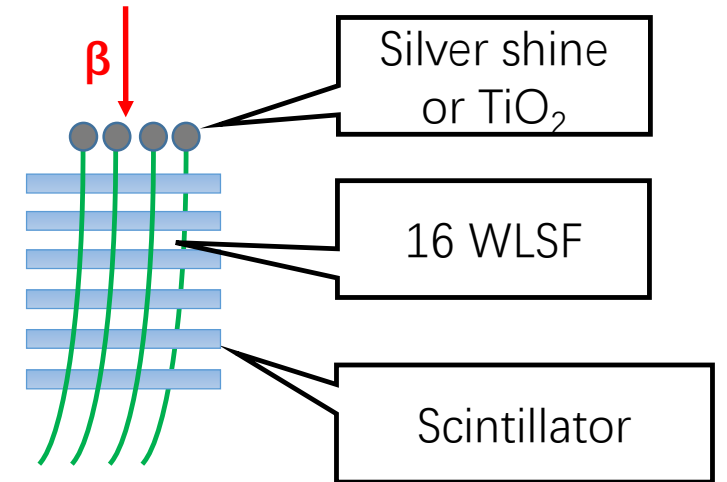

- Different scintillator

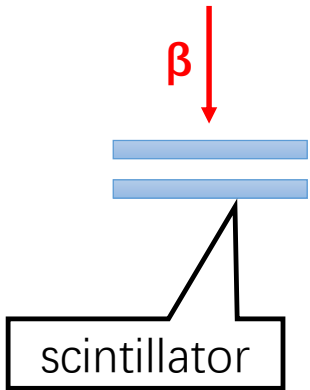

- Different reflective materials between lead and scintillator

