

# Exploring Different phi Segmentation for Shower-max

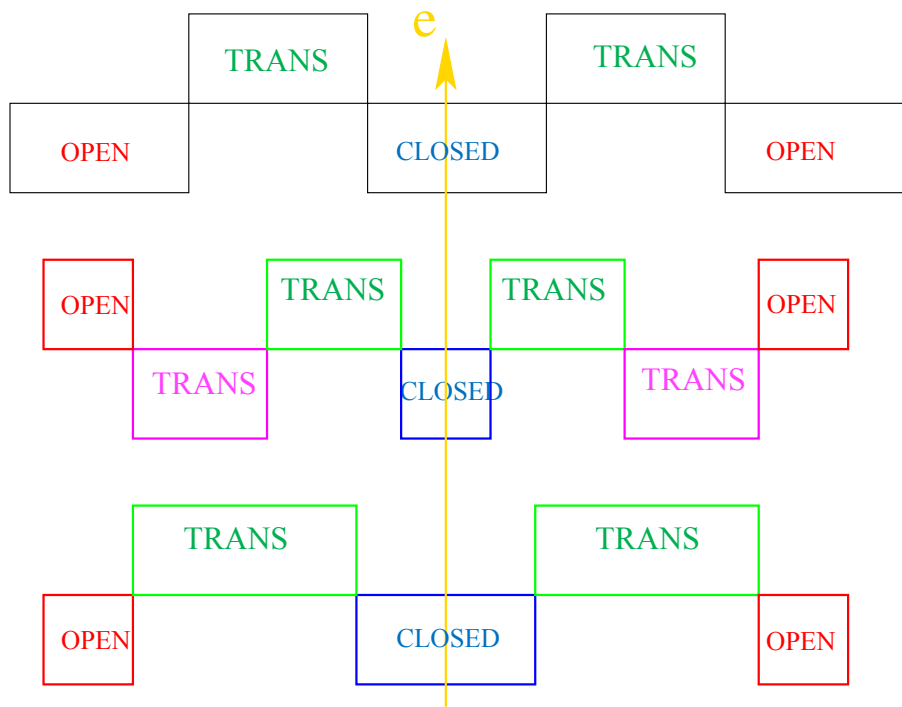

Radial view of various phi segmentation ideas

← Baseline (original)

← HalfOpen/HalfClosed

← HalfOpen/FullClosed

Half-width, “full-stack” Shower-max

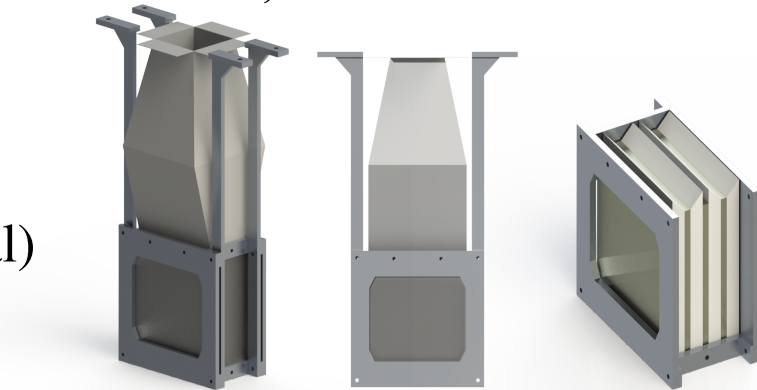

Full-width, “full-stack” Shower-max

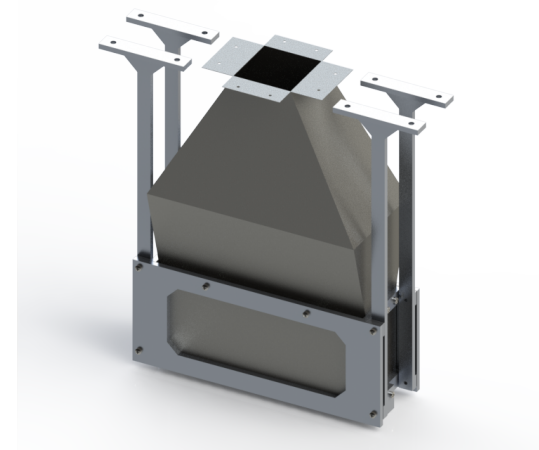

# Energy Acceptance for Different phi Segmentation

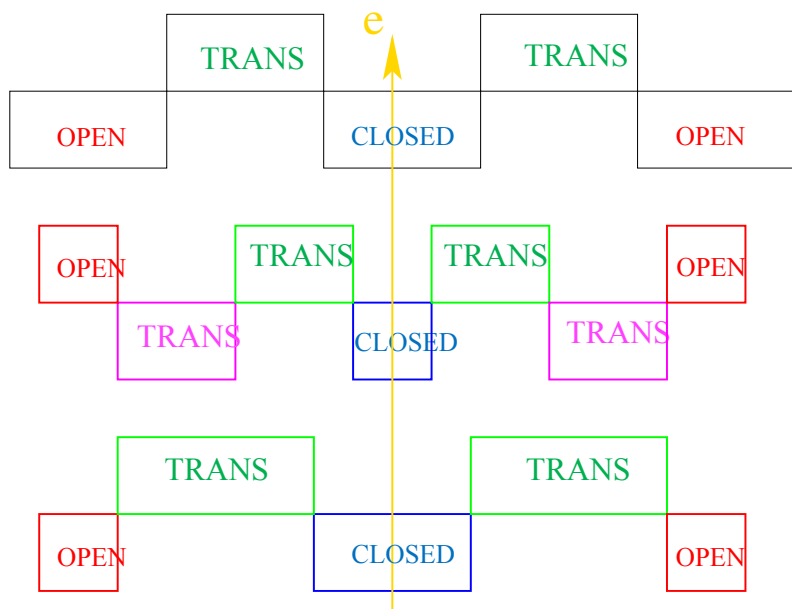

Radial view of various phi segmentation ideas

← Baseline (original)

← HalfOpen/HalfClosed

← HalfOpen/FullClosed

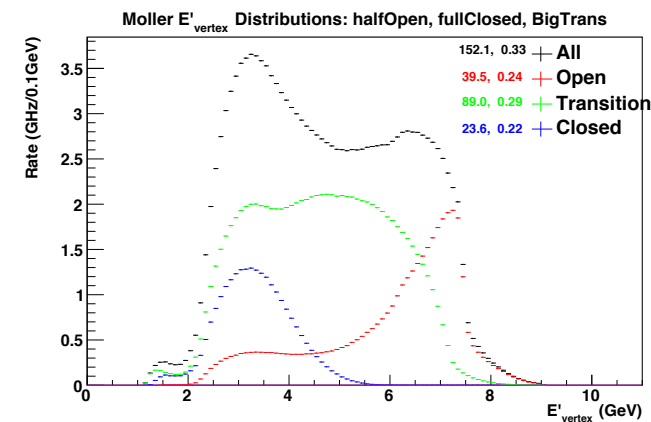
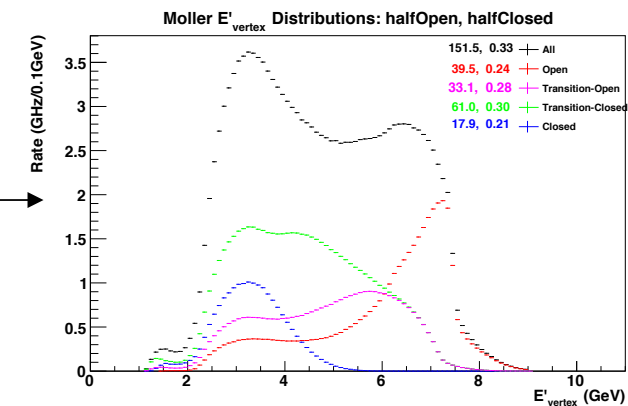
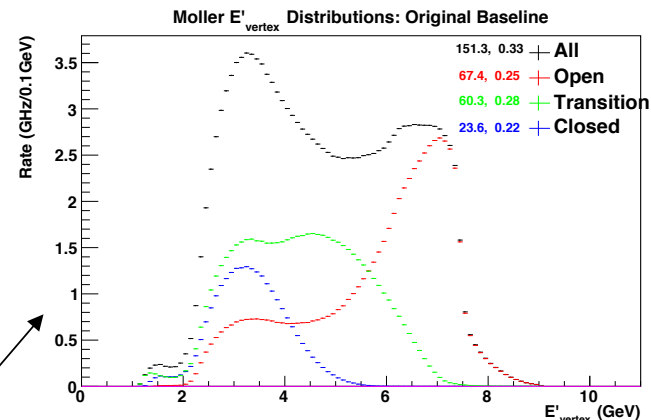

# Rate and $A_{\text{meas}}^{\text{PV}} * \text{Rate}$ – weighted Energy Acceptance

## Original Baseline

## half Open/ Full Closed

