

Streaming DAQ Update

- Finished most single chip measurements (linearity, time resolution, x-talk, etc.)
- Assembled complete readout system with GEM; cables + GEM inside Faraday cage to suppress noise
- Use Direct ADC Serialization (DAS) mode to take a pedestal run
- Create pedestal file consisting of Pedestal and σ_{Pedestal} for all 760 channels
- Create threshold file: **Threshold(chan) = Pedestal(chan) + 3* $\sigma_{\text{Pedestal}}(\text{chan})$**
- Modify SAMPA initialization software to read in threshold file and set thresholds for all channels
- Take cosmic ray run in DSP mode (zero suppression)

Cosmic Ray Test Setup

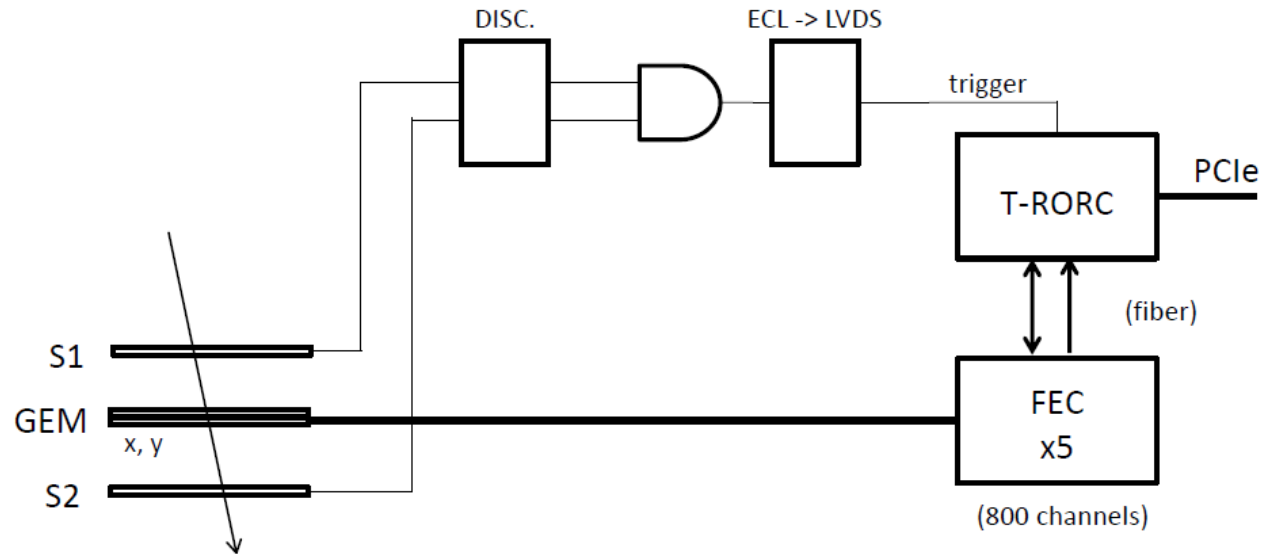

S1, S2 – plastic scintillators

GEM – 1x, 1y plane (384 channels each)

T-RORC – ALICE/ATLAS Read Out Receiver Card with GBT serialization protocol

FEC – ALICE Front End Card (JLAB version) – 5 SAMPA chips (160 channels)

We do not trigger the SAMPA chips. Data is continuously streaming from the FECs to the T-RORC. Receipt of a trigger causes a programmable window of streamed data to be captured by the T-RORC. This data is transmitted to the PC memory and written to disk.

- Most pulses are small amplitude noise pulses. We use these to verify that the thresholds have been programmed correctly for all channels.

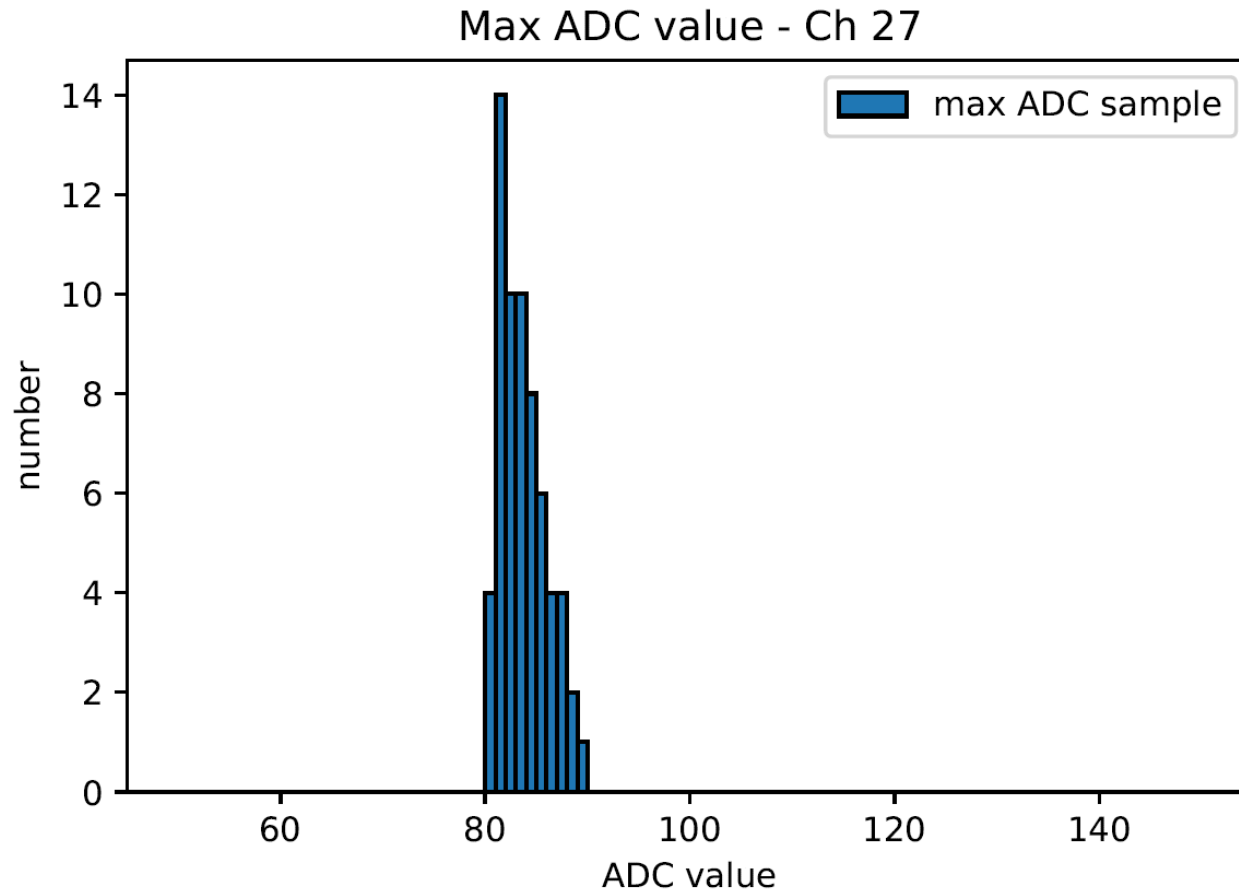

pedestal = 71.48 $\sigma = 2.80$ threshold = pedestal + 3* σ = 80

Cosmic ray candidate – cluster of adjacent channel hits with close times

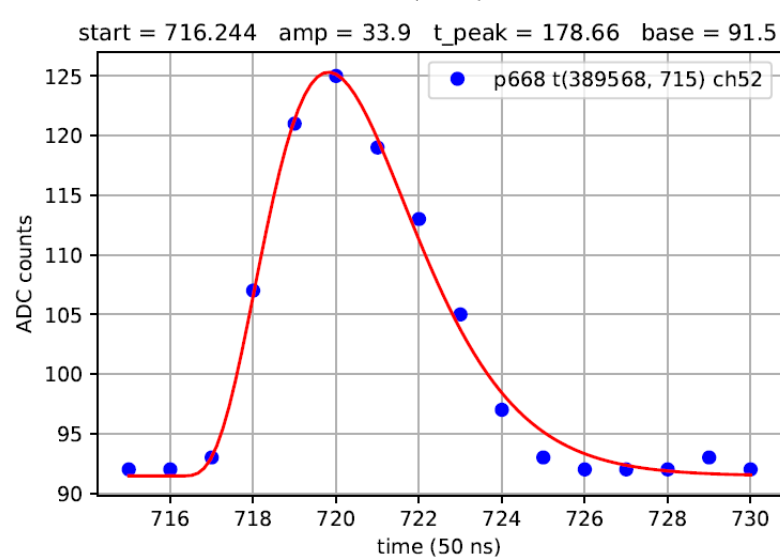
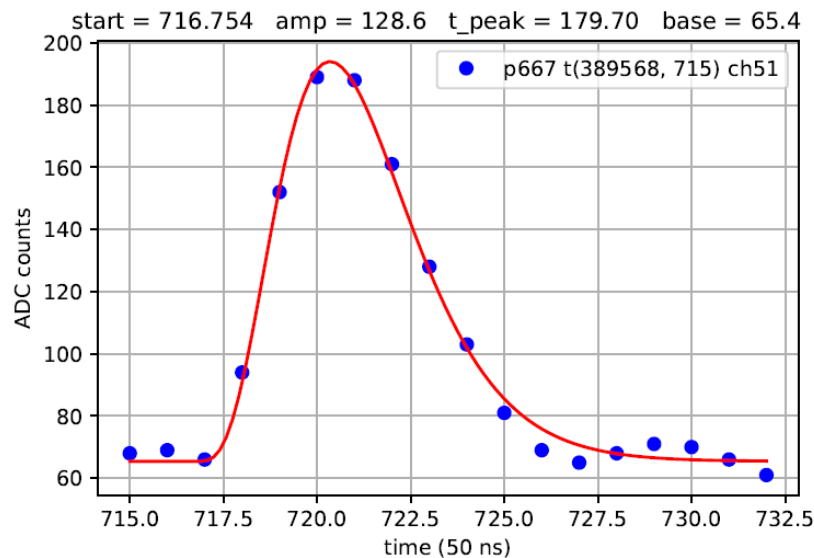
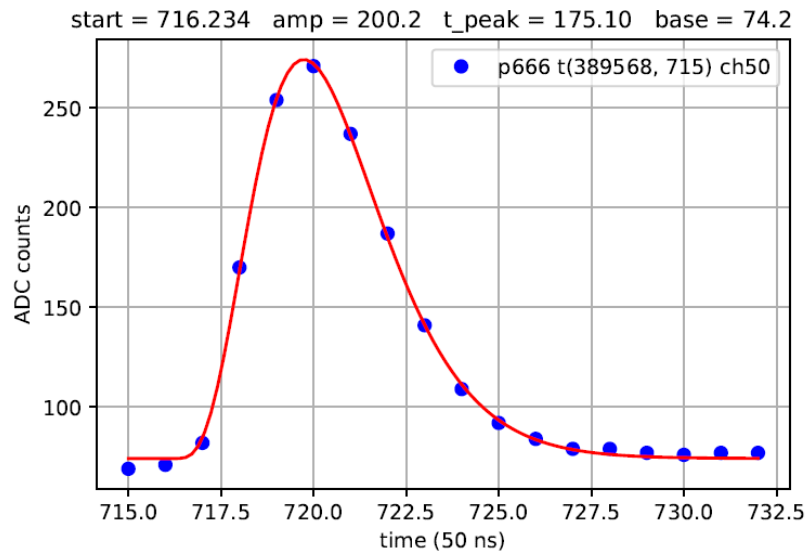
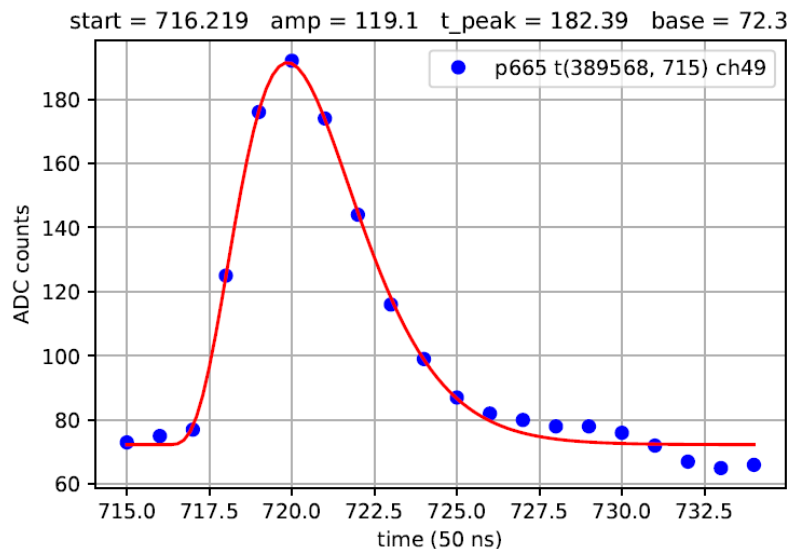

x-plane hit cluster

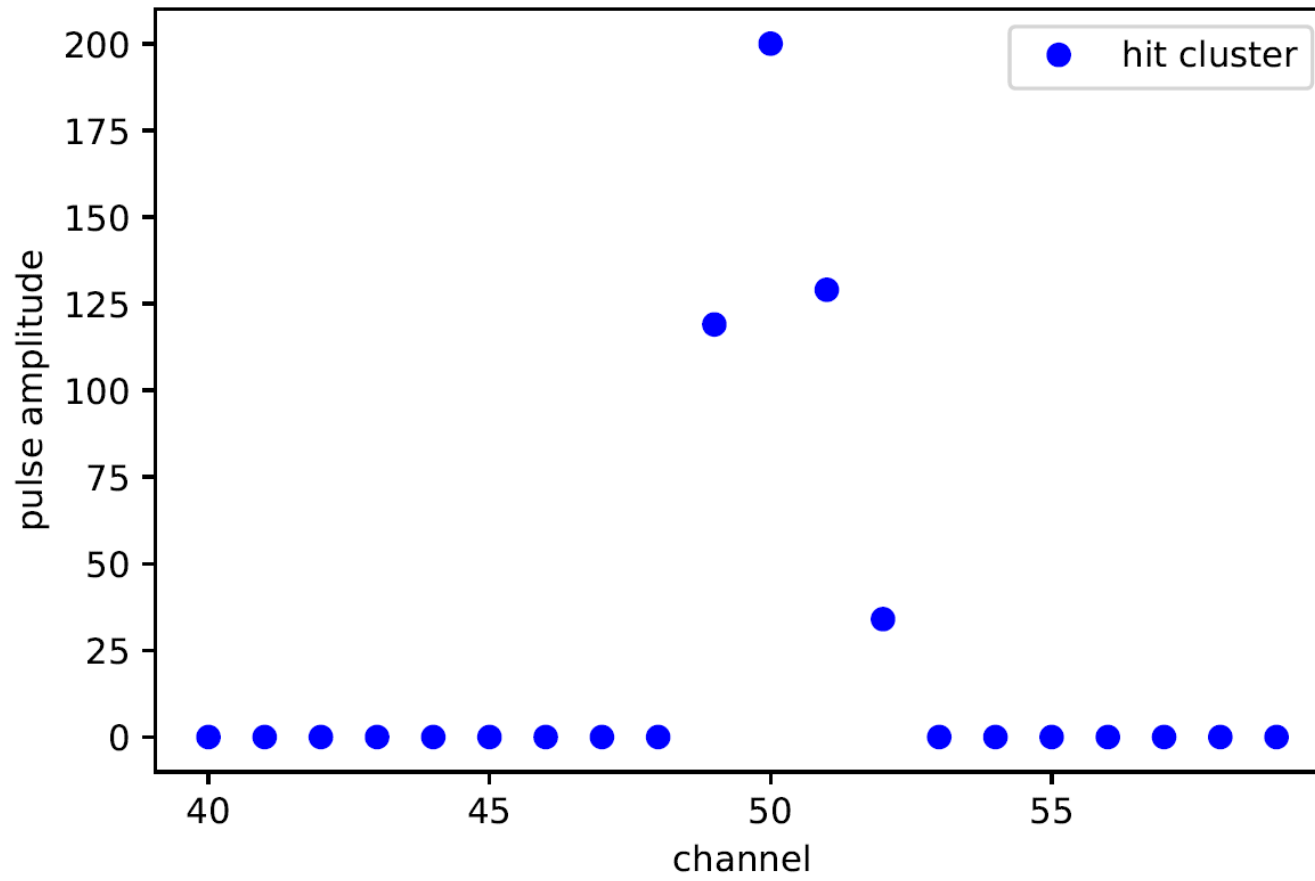

Pulse amplitude sum = 482 (48 fC)

- **x-plane cluster** should have a corresponding **y-plane cluster** with **close time**
- Working on automating cluster finding and matching of x and y clusters
- Check if distribution of amplitude sums for minimum ionizing cosmic rays is consistent with gain of GEM + SAMPA
- Study timing resolution from matched x and y clusters

Question for the GEM experts: For the geometry of this GEM (Mississippi State) what are typical numbers of strips hit in a cluster (almost normal incident cosmic rays)?