

HCAL Front End Layout

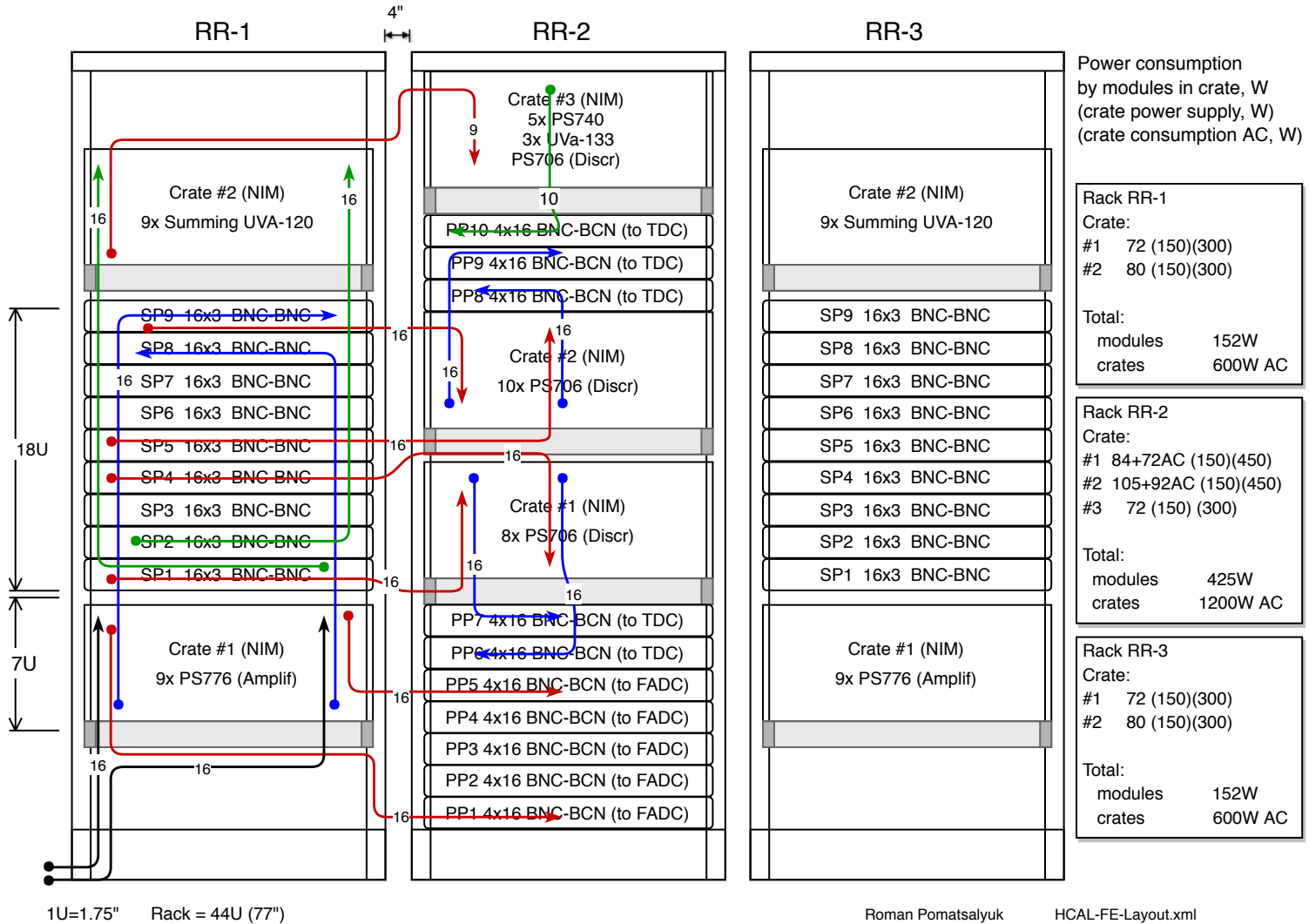

Module occupation

Rack RR-1
Crate #1 (NIM)
9x PS776

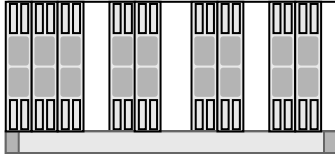

Rack RR-2
Crate #1 (NIM)
8x PS706

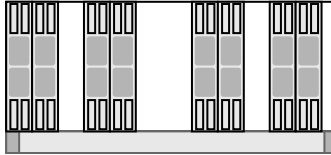

Rack RR-3
Crate #1 (NIM)
9x PS776

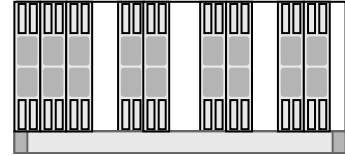

Rack RR-2
Crate #2 (NIM)
10x PS706

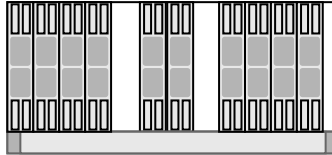

Rack RR-1
Crate #2 (NIM)
9x UVa-120

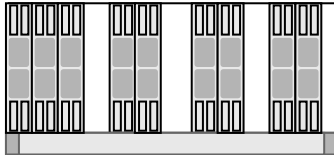

Rack RR-3
Crate #2 (NIM)
9x UVa-120

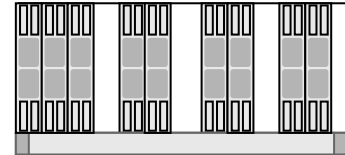

Rack RR-2
Crate #3 (NIM)
5x PS740, 3xUVa133, PS706

